

Rear of Body Trim



12-646S

12-646S
57
FIN CORNER
Molding Set
stainless steel,
all 3 pieces
337.00 R

- 12-646A 57 Vertical Fin Molding LEFT. Ea. (part of 12-646S) **99.00 R**
- 12-646B 57 Vertical Fin Molding RIGHT. Ea. (part of 12-646S) **135.00 R**
- 12-646C 57 GAS DOOR. Ea. (part of 12-646S) **99.00 R**

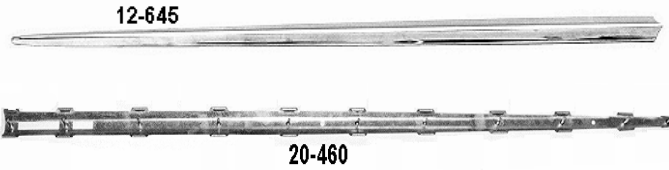

12-645

20-460

- 12-645 57 FIN MOLDING, Ea. B/A exc wgn, no insert **109.00 R**
- 12-645A 57 FIN MOLDING, Ea. B/A exc wgn, WITH insert **219.00 R**
- 20-460 Fin Molding INSERT w/pins attached, 57 B/A exc Wagon., Ea. [USA] **69.00 R**



12-645B

- 12-645B Fin Molding 57 210 & 150 models, molding only, for insert see 20-460G Each **75.00 RF**



20-460G

- 20-460G Fin Molding Insert 57 210 & 150 models, with pins attached Each **69.00 RF**



12-152

57 Accessory Aluminum TRUNK TRIM

- 12-152 3 piece set w/mounting hardware **N/A**
- 12-152D 3 piece set w/mounting hardware [Danchuk] **225.00 R**
- 12-154 Deck Trim MOUNT HARDWARE only, 57 silver **15.00 R**



20-007



20-174

- 20-007 Fin CORNER MOLDING CLIPS, 57, Pr. **14.00 R**

Fin Molding CLIPS

These have an Orange enamel finish These are the only ones made in the USA

- 20-173 Fin Molding Clip Set 57 Bel Air, Set of 22 **27.00 R**
- 20-173EA Fin Molding Clip 57, Each **2.50 R**
- 20-174 Fin Molding Clip Set, 57 '210'-'150', Set of 6 **9.50 R**



20-370



20-370B

Fin Molding PINS

- 20-370 57 Bel Air All except wagons Set of 22, **49.50 R**
- 20-370A 57 Bel Air Wagon, Set of 16 **36.00 R**
- 20-370B 57 210/150 models, Set of 6, all **17.00 R**
- 20-371 Fin Molding LONG REAR PINS, 57 Pr. w/nuts **7.60 R**
- 20-372 Fin Molding SHORT PINS, 57 repair pk/4 w/nuts **9.90 R**

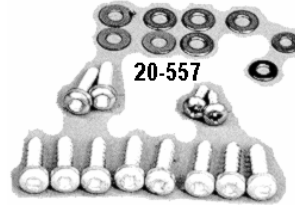

20-557

20-557 GAS DOOR SCREW SET, 57, all screws to mount hinges, filler neck to each other and to car, 20 pieces, w/clutch heads as required **N/A**
use 20-557RP

- 20-557RP GAS DOOR SCREW SET, same as 20-557 except phillips head replacement screws instead of clutch head originals **6.00 RP**
- 20-557A 57 FIN SCREW SET does Block-Off, Corner Moldings, Gas Dr Box to body, covers all items not previously supplied **5.00 R**

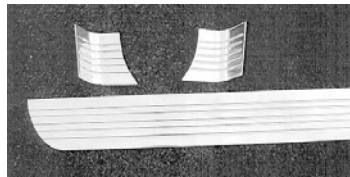

30-P57TT

57 BILLET TRUNK TRIM
3pc set attaches with double sided tape [Back Roads Fab.]
319.00 C



CONTINENTAL KITS

Complete kits made in Canada

We do not carry this item.

Call Continental Enterprises.

See Hemmings Motor News or call for phone #.



12-116

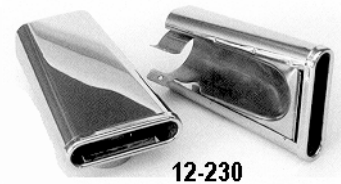

12-230

- 12-116 Accessory EXHAUST EXTENSION, 55-6 chrome, die cast w/crest, with mount hardware & deflector as original, Ea. fits all models **47.00 R**

- 12-230 55-6 POWERPACK EXHAUST EXTENSIONS PAIR
Factory original equipment on dual exhaust cars, Stainless Steel [made by Gene Smith] **184.00 R**

For custom tailpipe extension tips see Group 27 Exhaust

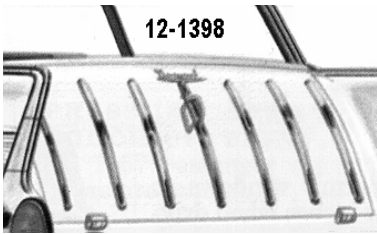

12-1398
 NOMAD TAILGATE BARS
12-1398 TAILGATE BAR SET, includes all 7 bars with center bar handle, 8 Pc Set USA **639.00R**

- 12-1398F** Nomad Tailgate Bar 7pc Set w/clips (Golden Star) **699.00RF**
- 12-1395** CENTER Bar, chrome, no handle, Ea. (USA) **210.00R**
- 12-1396** SIDE Bar, chrome, Set of 6. (Trim Parts) **470.00R**
- 12-1396EA** SIDE Bar, chrome, Each. (Trim Parts) **80.00R**
- 12-1397** Center Bar HANDLE, Each. (Trim Parts) **92.00R**



20-413 Nomad TAILGATE BAR CLIP SET
 Pack of 33, does all 7 bars USA **95.00R**

20-413



20-262

- 20-262** Nomad TAILGATE BAR CLIP, Set/5, does 1 bar **19.75R**



12-004

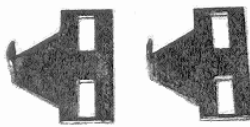

12-004A



12-663 on Slider
12-664 on Curved Glass

- 12-004** Nomad Slider Glass LATCH, Pr. **34.95RF**
- 12-004A** Nomad Slider Glass CATCH, Pr. **25.00R**
- 12-663** Nomad Slider Glass VERTICAL MOLDING Pr. **130.00R**
- 12-664** Nomad Curved Quarter Glass FRONT MOLDING Pr. w/whiskers attached **145.00R**

License Frames & Brackets

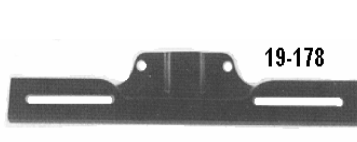

19-178



19-179

License Plate Mounting Brackets

- 19-176** 55 FRONT License Bracket **7.00R**
- 19-177** 56 FRONT License Bracket **7.00R**
- 19-178** 57 FRONT License Bracket **10.00R**
- 19-179** 55-6 REAR, on trunk-lid, except wagon **11.50RF**
- 19-179D** 55-6 REAR, on trunk-lid, except wagon Danchuk **28.00R**



20-277

20-277 REAR LICENSE PLATE MOUNTING KIT, 57, includes long spacers, seals etc. **8.80R**
 Note 57 bolts directly to trunk lid with this.



12-387



12-496A

ACCESSORY LICENSE FRAMES

- 12-380** 55 tubular adjustable stainless **Discontinued**
- 12-387** 56 adjustable chrome die cast **69.00RF**
- 12-496A** 57 Gold, die cast metal (Danchuk) **84.00R**
- 12-497A** 57 Chrome, die cast metal (Danchuk) **84.00R**



30-201A

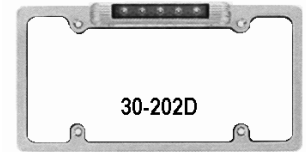

30-202D

Custom License Frames

- 30-201A** Brushed Aluminum **23.00**
- 30-201B** Chromed Aluminum **29.00**
- 30-202D** Chrome w/3rd Brake & Tag Lights **45.00**

- 20-219** LICENSE PLATE SCREW, washer head & nut Ea. **.30R**
- 23-107** License Plate SEALS, to trunk lid, Pr. **1.50R**
- 23-129** License Plate BUMPER, Ea. **.70R**

Chrome Side Glass Frames

Glass, Regulators, Tracks see Group 18



12-670T

ASSEMBLED Side Window SETS
 Pairs of Vent [w/latches], Door & Quarter Chrome Frames with Glass and door glass tracks, track rubbers do not have flaps

Ready to install in your car. Driver quality.

- Side Glass Set Assembled 2 Dr. HT 6pc Set **\$899. R**
12-670C CLEAR **12-670T** TINTED **12-670G** GRAY

- Side Glass Set Assembled Convertible 6pc Set **\$899. R**
12-672C CLEAR **12-672T** TINTED **12-672G** GRAY

SEDAN ASSEMBLED SIDE GLASS SET

- Glass mounted in glass tracks, chrome vent frames [with latches] assembled and ready to install 2 dr 6pc Set. Vents, Doors, Quarters.
 4 dr 8 pc. Set. Driver quality [no flap on door glass rubbers]
 2 Dr. Sedan **\$399.** 4 Dr. Sedan Tint **\$399.**
- 12-675C** 2 Dr. Sedan CLEAR **12-676C** 4 Dr. Sedan CLEAR
- 12-675T** 2 Dr. Sedan TINT **12-676T** 4 Dr. Sedan TINT
- 12-675G** 2 Dr. Sedan GRAY **12-676G** 4 Dr. Sedan GRAY

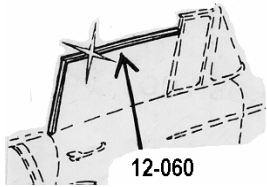

12-060

DOOR GLASS
Chrome Frame

Fits Left or Right side RF

- 12-060 2 dr. HT/CV. Each **85.00**
12-062B Nomad Each **95.00**

Door Window Frame 2d HT & Conv. w/tinted glass
Assembled frame glass & glass track Each \$ **195. R**
12-060AL Left 12-060AR Right

Quarter Window Frame UPPER SECTION

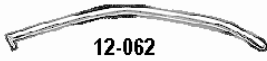

12-062



12-062A

- 12-062 Convertible, fits right or left **89.00 R**
12-062A 2 dr HT, fits Right or Left frame **59.00 R**

20-298 Window Frame SCREWS, all HT, Conv, 4 dr HT, for assembling chrome window frames, Set for 1 car **8.00 R**

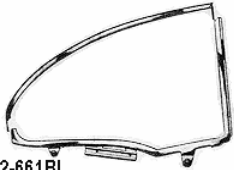

12-661BL

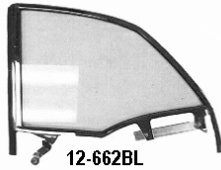

12-662BL

QUARTER WINDOW Frames

- Quarter Window Frame 2d Hardtop** w/ glass Assembled
12-661CL Left Tinted **235.00** 12-661CR Right Tinted **235.00**
12-661BL Left Clear **235.00** 12-661BR Right Clear **235.00**

- Quarter Window Frame Convertible** w/ glass Assembled
12-662CL Left Tinted **235.00** 12-662CR Right Tinted **235.00**
12-662BL Left Clear **235.00** 12-662BR Right Clear **235.00**

VENT WINDOW Frames



12-097CD1

PAIR \$169.00 R [Golden Star]
12-097AB-GS HT/Nomad w/latch
12-097CD-GS Sedan/Wagon w/latch

12-097EF Convertible, Pair No latch
as original can be used on HT or
Nomad if no latch desired
[UNFAIR ADVANTAGE] **97.00**

Discontinued when stock is

EACH [Golden Star] Vent Frames
\$90.00 EACH

- 12-097A HT/Nomad w/latch Left
12-097B HT/Nomad w/latch Right
12-097C Sedan/Wagon w/latch Left
12-097D Sedan/Wagon w/latch Right
12-097E Convertible, No latch Left
12-097F Convertible, No latch Right



12-097G

Vent Window CAP Molding
Polished Stainless Steel

- 12-097GEA 55-7 2dr HT, 55 Conv., Nomad Each **21.00 R**
12-097H 56-7 Conv., Nomad & 4d HT, Pair **55.00 R**
12-097HL 56-7 Conv., Nomad & 4d HT, Left only **28.00 R**
12-097HR 56-7 Conv., Nomad & 4d HT, Right only **28.00 R**

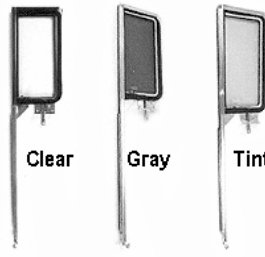

Clear Gray Tint

2 & 4 Dr Hardtop

Vent Window & Division Bar Assembly

Chrome frame, division bar, seals & U channel assembled includes cap molding on top of assembly [HT & Cv] & adjuster Each RF

Glass color: add Letter to Part #
Clear add 'C', original Tint 'T'.

Model	Drivers Side	Passenger Side	
Sedan & standard Wagon	<u>12-095A-L</u>	<u>12-095A-R</u>	429.00
Hardtops 2 & 4 door	<u>12-095B-L</u>	<u>12-095B-R</u>	429.00
Convertible.	<u>12-095C-L</u>	<u>12-095C-R</u>	429.00
Nomad	<u>12-095D-L</u>	<u>12-095D-R</u>	429.00



12-092AL

Vent Window DIVISION BAR only

Stainless Trim, Felt & Vent Seal attached Each \$ **135.00 RF**

- 12-092AL HT/Conv. Left 12-092AR HT/Conv. Right
12-092BL Sdn/Wgn. Left 12-092BR Sdn/Wgn. Right



12-093BL

Vent Division Bar Stainless Trim
Pair \$ **45.00 R**

- 12-093AL HT/Conv/Nomad L
12-093AR HT/Conv/Nomad R
12-093BL Sdn & Wgn L exc Nmd
12-093BR Sdn & Wgn R exc Nmd

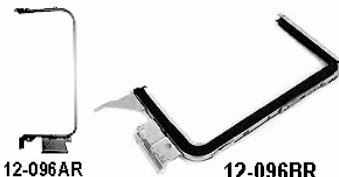

12-096AR

12-096BR

Vent Rubber Frames

The metal pieces the Vent rubber is mounted in. Attached w/ a rivet and a screw to the division bar. HT/CV includes the rubber seal, Sedans are the metal frame only

- 12-096BL HT/Conv. Left 12-096BR HT/Conv. Right **179.00** Each
12-096AL Sdn/Wgn. Left 12-096AR Sdn/Wgn. Right **112.00** Each



12-185B

- 12-185B Vent LATCH, Pr. w/rivets **70.00 R**
12-185BL Vent LATCH, Left. w/rivets **35.00 R**
12-185BR Vent LATCH, Right. w/rivets **35.00 R**



20-401

Vent Assembly Fasteners
to assemble vent moldings, rubber & regulator, both sides

- 20-401 Set 2 dr HT, Conv, Nomad, 4 dr HT, 60 pieces **17.00 R**
20-402 Sedans & Wagons except nomad **4.40 R**



20-401R1

Vent Window Division Bar ADJUSTER
bottom of vent window bar to door

- 20-401R RP, does 1 side, includes 1 stud, 2 nuts, 2 star washers, Instructions. Each **4.00 Rp**
20-401R1 HT/Conv/Nomad models, repro, Each **8.50 R**
20-401R2 Sedan models, repro, Each **8.50 R**



20-401R2

Windshield Moldings



12-161B

Lower Moldings
3 pc set **165.00 RF**
12-161A 55-56
12-161B 57



12-161BL

Lower Molding
Each \$ **84.00 RF**

12-161AL Lower Left 55-56
12-161BL Lower Left 57

12-161AR Lower Right 55-56
12-161BR Lower Right 57



12-162BL

Upper Moldings RF
Hardtops & Nomad
12-162A Pair **189.00**
Sedan & Wagons exc. Nomad
12-162BL Each LEFT **95.00**
12-162BR Each RIGHT **95.00**

Windshield Lower Corner Molding

All Except '150' models Each **N/A**
12-D15618 Left 12-D15619 Right



We also have good used moldings, cleaned & polished **CALL**

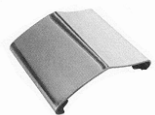

12-213

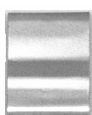

12-245

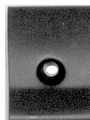

12-243

Windshield Molding Center Connectors

12-213 Upper center **13.90 R**

12-245 Lower center **7.00 R** 12-245D Lower center Danchuk **13.90 R**

12-243 Dash Garnish Molding CENTER CLIP at windshield **8.90 R**
Other Interior Garnish Moldings see Group 26

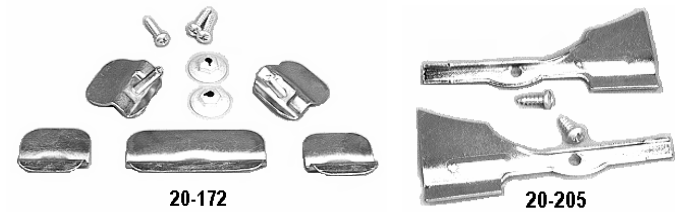

20-172

20-205

20-172 Windshield Lower MOLDINGS CLIP SET of 5 USA made **14.70 R**
20-205 Windshield Molding LOWER CORNER MOLDING CLIPS, Pr. USA made **12.50 R**
Windshield Pillar Molding SCREWS
20-188 Set all models except Convertible, plated **4.40 R**
20-188SS Set all models except Convertible, stainless **6.00 R**



Wiper Escutcheons (Bezels)

12-131 57 chrome w/nuts, Pr 2nd design [2" wide] **43.00 RF**
12-131A 57 chrome w/nuts, Pr. (Danchuk) [1-7/8 wide] **49.50 R**
12-335 55-6 chrome, w/nuts, Pr 2nd design [smaller] **43.00 RF**
12-335A 55-6 chrome Pr. w/nuts (Danchuk) **51.45 R**
12-335B 55 '150' chrome Pr. w/nuts (Danchuk) **51.45 R**
16-116T Wiper Escutcheon NUT TOOL **15.50**

Convertible WINDSHIELD MOLDINGS



12-15919

12-15919 UPPER MOLDING Made in USA [CARS] **N/A**
12-15919F UPPER MOLDING Foreign made version **128.00 RF**



12-091A PILLAR POST Moldings Pr **97.00 R**

20-396A Convertible Windshield PILLAR MOLDING SCREWS only included in 20-396 8 pc **3.00 R**

12-091A

20-396 Windshield Frame Moldings & Hardware SCREWS, Convertible (inside side & upper, outside upper) includes 20-397, 398, 353; stainless steel Set w/star washers **11.00 R**



12-15240

12-15240 Outer SIDE WINDSHIELD MOLDINGS Pr. **Discontinued**

Rear Window Moldings

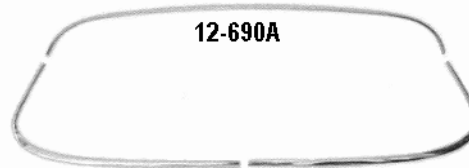

12-690A

12-690B



20-143

20-419

12-690A UPPER Molding 2 Dr HT, Each **159.00 R**
12-690B LOWER Moldings 2 Dr HT, Pair **245.00 R**
12-690S MOLDING SET of 3, 2 Dr HT **340.00 R**
12-691A UPPER MOLDING Sedans, Each **159.00 R**
12-691B LOWER MOLDINGS Sedans, Pair **245.00 R**
12-691S MOLDING SET of 3, Sedans **340.00 R**

Back Window MOLDING CLIPS

20-143 Set of 15 Standard number used originally USA **8.00 R**
20-419 Set of 22 for those who want to use more USA **10.00 R**

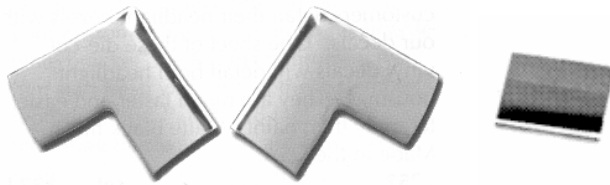

12-488

12-246

Rear Glass 'L' Shaped Corner Moldings

- 12-352 All sedans, stainless w/clips, Pr. **19.75 RF**
- 12-352D All sedans, stainless w/clips, Pr. Danchuk **25.00 R**
- 12-488 All 2 dr. hardtops, stainless w/clips, Pr. **19.75 RF**
- 12-488D All 2 dr. hardtops, stainless w/clips, Pr. Danchuk **25.00 R**

- 12-246 Rear Window Molding LOWER MIDDLE Connector, Sedans & 2 dr HT stainless, connects halves of lower back glass molding **7.00 RF**
- 12-246D Rear Window Molding LOWER MIDDLE Connector Danchuk version of #12-246 **16.90 R**

Windshields & other Glass see Glass section at the end of Group 1

BELT MOLDINGS



Door BELT Molding
HT &
CONVERTIBLE

- 12-D15671 Left, top of door **74.00 R**
- 12-D15672 Right, top of door **74.00 R**
- 12-D15615 PAIR **140.00 R**

Belt Molding SCREWS

Enough to do 2 belt moldings; top of door or quarter, below glass

- 20-187 Door, HT/CV/Nomad, plated **3.30 R**
- 20-187SS Door, HT/CV/Nomad, stainless steel **7.00 R**
- 20-187A Quarter Panel, HT/Convert. plated **3.00 R**

Flipper & Quarter Rooftrack Mounting SCREWS

- 20-187B 2 dr HT, includes oversize screws for stripped holes & screws for inner qtr window to rear window trim, 40 pc **6.50 R**
- 20-187C Quarter ROOF MOLDING only, 2 dr HT, Set / 10 screws & 6 J nuts **3.60 R**



12-674R

Convertible
Quarter Window
BELT Molding

- 12-674L-2 Left **200.00 R**
- 12-674R-2 Right **200.00 R**
- 12-674PR Pair **350.00 R**



12-580

DOOR BELT MOLDING '210' 2d Sedan

- 12-580 BELT Molding '210' 2dr Sedans & Wagons except Nomad 3/4" wide fits just under the door glass, Left & Right the same. Each **85.00 RF**
- 20-454D Door Belt Molding CLIPS '210' 2 dr or 4 dr Sedan or Wagon does one molding [10 clips] **25.00 R**

See GROUP 20 for complete Belt Molding Clip Set Listings

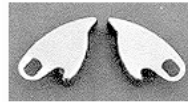

12-439A1

12-439A1 Belt Molding CONNECTOR on post between doors 55-7 Bel Air 4 dr Sedan



12-644

12-233

Repro
Outside
Visors
see Group 11

- 12-233 OUTSIDE SUNVISOR BRACKETS, Pr. to mount accessory visor to center of roof **Discontinued**
- 12-644 Outside Sunvisor STAINLESS END CLIPS, Pr. Sedans/Wagons, replacement for HT **25.00 RF**

Group 12B Interior Chrome & Accessories

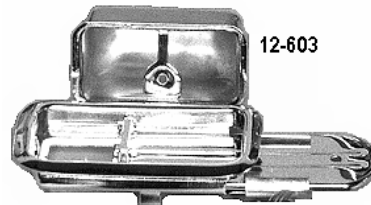

12-603

12-604

ASHTRAY
Rear Seat
2 dr HT's & Conv.
12-603 INSERT only, Ea. **13.90 R**
12-604 SLIDING Door Ea. **24.00 R**



12-613A

12-613A Rear Seat 55-6 2 Dr Sedan fits in bolt-on armrests polished stainless. Pr. **89.00 R**

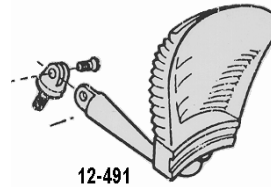

12-491

TRAFFIC LIGHT VIEWER
mounts on dash garnish molding screw or drill hole in top of dash. See overhead traffic signals. 55-7
12-491 USA Trim Parts **59.00 R**
12-491F Foreign version **52.00 RF**

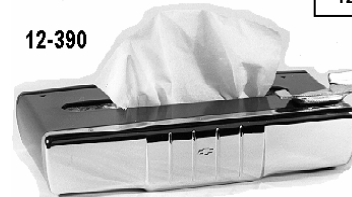

12-390

TISSUE DISPENSERS
underdash accessory **\$69.00 R**
12-390 55 12-493 56 12-494 57
12-622 Tissue Refill **3.00**
12-623 Dispenser EMBLEM 56-7 **15.00 R**

Convertible only Interior



12-001A

12-159

12-160

- 12-001 Conv top switch KNOB/SHAFT ASSEMBLY 55-6 **30.00 R**
- 12-001A Conv top switch KNOB/SHAFT ASSEMBLY 57 **35.00 R**
- 12-159 Top Latch STRIKER PLATE, Conv., chrome, Ea. **30.00 R**
- 12-160 SUNVISOR HOOK, Ea. **N/A** Use 12-160A below
- 12-160A SUNVISOR HOOK, Convertible, chrome, Pr. **45.00 R**
- 20-397 Top Striker Plate SCREWS Convertible, SS, SET/4 **3.30 R**

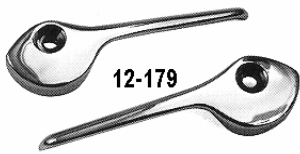

12-179



12-179SL

12-179 TOP HOLDOWN HANDLES chrome Conv., Pr. **75.00 R**

Top Handle ASSEMBLY 3pc incl: handle, cover plate & mechanism.
Different manufacturer than individual #'s Each **99.00 R**

12-179SL Left 12-179SR Right

20-353 Top Handle SCREWS, Convertible, stainless steel,
55-8, Pr. w/ star washers **2.50 R**



12-179A

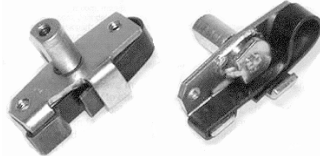

12-179B

12-179A Top LATCH PLATES, plates & screws that go round
top latch handles, Conv., Pr. **23.00 R**

12-179B Convertible Top Handle MECHANISMS Pr. **135.00 R**

12-630A 12-9386 12-159

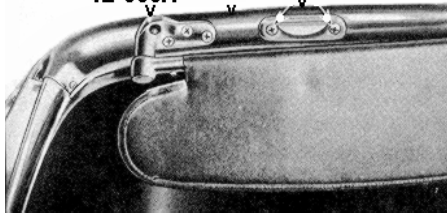

Windshield
Frame TOP
INNER
MOLDINGS
Convertible

12-9386 Pr. (Long pieces under visors) USA version **N/A**

12-9386F Pr. (Long pieces under visors) Import version **225.00 R**



12-630A

12-630A-1 Inside
Sunvisor Brackets,
Conv., Pr. **135.00 R**

20-398 Sunvisor SCREWS, Convertible, stainless steel,
Set of 6 w/star washers **2.80 R**



12-063

12-063 Windshield DIVIDER STRIP,
convertible, stainless piece that goes under
inside mirror support **30.00 R**

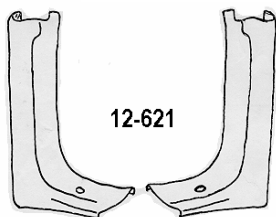

12-621



20-396

12-621 Windshield Pillar GARNISH MOLDING, Convertible
inside 55-7, Pr. Show Quality **N/A**

20-396 Windshield Frame MOLDINGS & HARDWARE SCREWS,
Convertible (inside side & upper, outside upper) includes
20-397, 398, 353; stainless steel Set w/star washers **11.00 R**

20-396A Convertible Windshield PILLAR MOLDING SCREWS
only included in 20-396 8 pc **3.50 R**

Door Sill Plates



12-117

All 2 Door w/Fisher tags attached & screws Pr.

12-117D Door Sill Plates 2 door best Danchuk **67.00 R**

12-117F Door Sill Plates 2 door Fargo **49.00 RF**

12-117FGS Door Sill Plates 2 door Golden Star **59.90 RF**

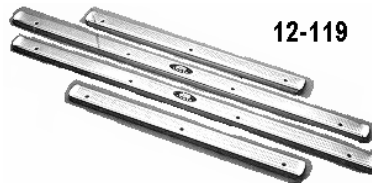

12-119

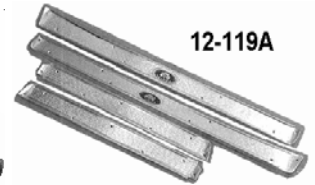

12-119A

All 4 Door Except 4 dr HT w/Fisher tags attached & screws Pr.

12-119D Door Sill Plates Set/4 best Danchuk **135.00 R**

12-119F Door Sill Plates Set/4 Fargo **89.00 RF**

12-119A 56-7 4 Dr. Hardtop only, Set/4 wide style **199.00 RF**

20-156 Door SILL PLATE SCREWS Pack/10, chrome **1.50 R**

20-156SS Door SILL PLATE SCREWS, Pack/10, stainless **3.00 R**

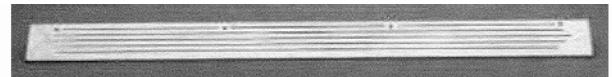

12-117A1

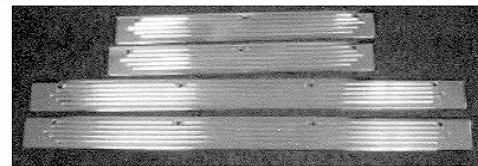

12-119B

Billet Door Sill Plates

12-117A1 2 Dr, 5 milled lines only, polished, Pr. **279.00 C**

12-119B 4 Dr, Sedan/Wagon Set/4 ball milled, polished **290.00 C**

HORN RINGS & TRIM

STEERING WHEELS & related parts See Group 17C page **83-87**



12-156

57 HORN RING
Bel Air & 210
chrome

12-156 Gene Smith
109.00 R

12-156D Danchuk
159.00 R



12-157

Emblem CHROME BEZEL

12-157 57 B/A, 210 [Gene Smith] **34.00 R**

12-157D 57 B/A, 210 [Danchuk] **37.00 R**



12-126

57 HORN RING PLASTIC EMBLEMS

- 12-126 Bel Air (Trim Parts) best quality **36.00 R**
- 12-126F Bel Air (Danchuk) **39.00 R**
- 12-127 210 (Trim Parts) **49.50 R**
- 12-127F 210 (Danchuk) **35.90 R**
- 12-127A 150's that use B/A- 210 horn ring **49.50**

57 HORN RING ASSEMBLY INCLUDES Ring, Bezel and Emblem.

- 12-158B Bel Air Gene Smith **169.00** 12-158BD Bel Air Danchuk **189.00**
- 12-158C '210' Gene Smith **169.00** 12-158CD '210' Danchuk **189.00**

- 12-157D1 Horn Ring EMBLEM & BEZEL Bel Air Danchuk **64.00 R**
- 12-157D2 Horn Ring EMBLEM & BEZEL '210' Danchuk **64.00 R**

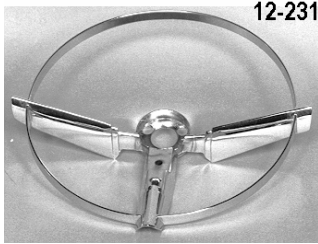

12-231

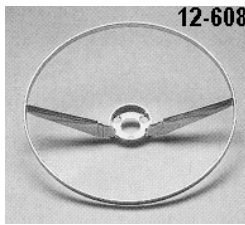

12-608

55-56 HORN RINGS

- 12-231 Bel Air 55-6 chrome. [Gene Smith] **103.00 R**
- 12-231D Bel Air 55-6 chrome. [Danchuk] **165.00 R**
- 12-608 '210' models, 55-6 chrome. [Gene Smith] **99.00 R**



12-548



12-550, 51

55-6 HORN CAP EMBLEMS

- 12-532 V8 gold, Bel-Air, Best (USA, Gene Smith) **20.00 R**
- 12-547 V8 gold, Bel-Air, foreign **14.50 R**
- 12-533 V8 chrome, 210, Best (USA, Gene Smith) **20.00 R**
- 12-548 V8 chrome, 210's foreign **13.00 R**
- 12-550 6 cyl. gold, Bel Air's (USA, Gene Smith) **20.00 R**
- 12-551 6 cyl. chrome, 210's (USA, Gene Smith) **20.00 R**

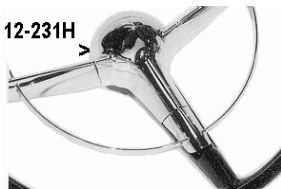

12-231H

55-6 Bel Air Horn Ring CENTER CAP

- 12-231E Stock **39.00**
- 12-231F No Holes **34.00**
- 12-231G Chrome w/Holes **54.00**
- 12-231H Chrome No Holes **54.00**

- 17-179 Horn Ring RETAINER SCREW, orig. washer head, ea. **1.00 R**
- 17-179A Horn Ring CENTER CAP SCREWS, 55-6 B/A **2.00 R**
- 17-179B Horn Ring CENTER CAP SCREWS, 57 B/A & '210' **2.00 R**
- 17-170 Horn Contact INSULATOR **5.00 R**
- 17-150 Horn CONTACT **9.50 R**



17-200

HORN RING REPAIR KITS made in USA; w/instructions. **\$25.00 R**
17-200 55-56
17-201 57

- 17-200D Horn Kit Danchuk 55-6 BA/210 **29.00 R**
- 17-201D Horn Kit Danchuk 57 BA/210 **29.00 R**

Inside Mirrors

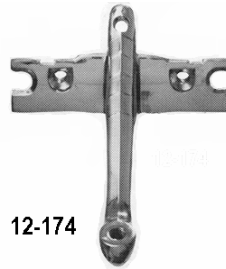

12-174

INSIDE MIRROR Supports



12-287A

- 12-174 Convertibles, chrome **49.50 RF**
- 12-287 Sedan & HT's, chrome Fargo **29.90 R**
- 12-287A Sedan & HT's, chrome Danchuk **38.00 R**



12-301



12-016

- 12-301 INSIDE MIRROR, standard, all, chrome back **22.95 RF**
- 12-301D INSIDE MIRROR, standard Danchuk **34.00 RF**
- 12-016 VANITY MIRROR, original accessory clips on to sun visor, ea. **N/A**



12-552



12-537



12-552B

DAY-NIGHT INSIDE MIRRORS

- 12-552 55 [Does **NOT** Need 12-537] **45.00 RF**
- 12-552A 56 [NEEDS 12-537] **60.00 RF**
- 12-552B 57 [NEEDS 12-537] **49.90 RF**
- 12-537 Day-Night Mirror MOUNTING BRACKET, mirror to support 56-7 **19.90 R**



12-453



Sunvisor Brackets except Convertible

- 12-453 Inside Sunvisor Supports, exc. Cv., Pr. **34.00 RF**
- 12-453A Inside Sunvisor Supports, exc. Cv., Pr. Danchuk **47.00 R**
- 20-004 Interior SUNVISOR SCREWS, exc Cv. Set/6 **1.80 R**

Inside Handles, Levers, Knobs



12-140

- 12-140 TURN SIGNAL LEVER w/Knob **9.90 R**
- 12-140D TURN SIGNAL LEVER w/Knob [Danchuk] **12.90 R**
- 12-346 Turn Signal Lever KNOB **N/A** Use 12-250A
- 17-177C SCREW Turn Signal Lever to Housing w/lock washer **1.50 R**



12-389

- 12-389 GEAR SHIFT LEVER w/Knob **32.00 R**
- 12-250A Gear Shift & Turn Signal Lever KNOBS **9.89 R**



- 20-348 Gear Shift HANDLE SPRING, goes on end of lever where it enters steering column **2.50**
- 20-348A Gear Shift HANDLE PIN, holds lever to column **2.30**
- 23-146 SHIFT LEVER BOOT, at Steering Column **5.50**

Other dash Knobs see Group for item they control. Radio Knobs in radio group page **103**, etc. Note: Inside Handles come with clips.

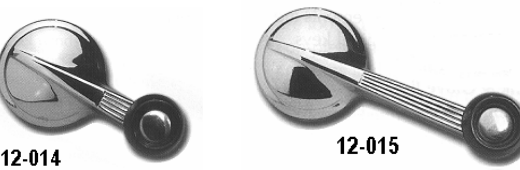

- 20-107 Inside Handle TENSION SPRING, Ea. **.90**
- 20-195 Inside HANDLE CLIP, Ea. **.25**

INSIDE HANDLES

- 23-194 Inside HANDLE WASHER, Upholstery washer, Ea. **1.70R**
- 12-013 Inside Door Handles, Pr. [Danchuk] **39.00R**
- 12-187 Inside Door Handle, Ea. **15.95RF**
- 12-014 Vent Window Crank, Pr. [Danchuk] [Note these will not work with original regulators since recent rerun] **34.00R**
- 12-185 Vent Window Crank, Ea. **14.95RF**
- 12-015 Window Crank, Pr. [Danchuk] [Note these will not work with original regulators since recent rerun] **34.00R**
- 12-186 Window Crank, Ea. **14.95RF**



BILLET BALL MILLED INSIDE HANDLES

- 30-IHV556P Vent Handles, Inside, Pr. **169.00**
- 30-IHD556P Door Handles, Inside, Pr. **159.00**
- 30-IHW556P Window Handles, Inside, Pr. **175.00**

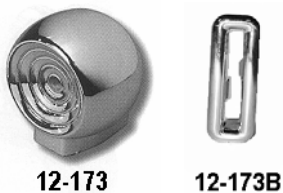

- 12-173 Seat KNOB, chrome *Use 12-173A*
- 12-173A Seat KNOB, chrome, best quality **12.80R**
- 12-173B Seat Knob BEZEL in Seat Shell, all (stainless) **17.00R**

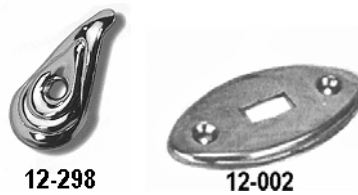

- 12-298 Inside COAT HOOKS, Pr., chrome **N/A**
- 12-298D Inside COAT HOOKS, Pr., chrome Danchuk **15.40R**
- 20-004A COAT HOOK SCREWS, chrome, Pr. **1.00R**

12-002 Lamp SWITCH COVER Nomad Rr Dome Light Switch **7.25R**



EMERGENCY BRAKE HANDLES
'E' Brake Parts see Group 22 Page 143

- 12-197 Chrome **32.00RP**
- 12-197A Original Black plastic **23.00R**
- 12-197AD Original Black plastic [Danchuk version] **29.00R**
- 12-197M All Metal Black powder coat **32.00RP**
- 12-197D Polished billet plain (Back Roads Fab.) **78.00C**
- 12-197E Polished billet Ball milled (Back Roads Fab.) **77.00C**

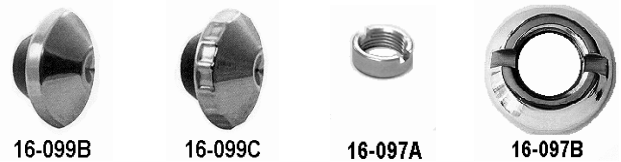

- Wiper Control Knobs**
- 16-099A 57 Bel Air and '210' **15.50R**
 - 16-099B 55 Bel Air **10.80R**
 - 16-099C 56 Bel Air **10.80R**
 - 16-097A Wiper SWITCH NUT to dash 57 Ea. **4.00R**
 - 16-097B Wiper SWITCH NUT to dash 55-6 Ea. **11.00R**

Headlight Switch KNOB

-
- 21-215C 55 Bel Air **17.50R**
 - 21-215C-2 55 Bel Air new supplier not quite as nice as 21-215C **9.00R**
 - 21-215C1 56 Bel Air **17.50R**
 - 21-215C1-2 56 Bel Air new supplier not quite as nice as 21-215C1 **9.00R**

-
- 21-216C 57 Bel Air **17.50R**
 - 21-216C-2 57 Bel Air new supplier not quite as nice as 21-216C **9.00R**

-
- 21-215N Headlight Switch NUT **21-215N**, 55-6 holds switch to dash **14.75R**
 - 21-216N 57 has 3 extra threads **15.50R**



12-625 **12-626** **12-615B**

CIGARETTE LIGHTERS

- 12-625 55 Bel Air w/housing & retainer **53.00 RF**
- 12-625A-1 55 Bel Air w/housing & retainer [Danchuk] **59.00 R**
- 12-626 56 Bel Air w/housing & retainer **53.00 RF**
- 12-626A-1 56 Bel Air w/housing & retainer [Danchuk] **59.00 R**
- 12-615B 57 Bel Air / 210 w/housing & retainer **53.00 RF**
- 12-615BD 57 Bel Air / 210 w/housing & retainer [Danchuk] **59.00 R**
- 12-626A 56 Bel Air lighter only **N/A**
- 30-556LIT Billet CIGARETE LIGHTER & Bezel Kit, 55-6 **76.00 C**

55-6 Dash Control Indicator Bezel SETS

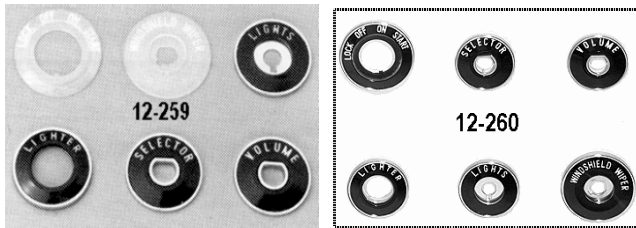

12-259

12-260

- Sets with CHROME BACKPLATES**
- 12-259 150-210, 'TrimParts' 12-269, 71, 78, 79, 80, 81, **59.90 R**
 - 12-259D 150-210, 'Danchuk' version of 12-259 **49.90 R**
 - 12-260 Bel Air, 'TrimParts' 12-276, 77, 78, 79, 80, 81, **68.00 R**
 - 12-260D Bel Air, 'Danchuk' version of 12-260 **49.90 R**

PLASTICS ONLY SETS

- 12-258 '150'-'210' Includes 12-269, 71, 72, 73, 74, 75, **38.00 R**
- 12-258D Bel Air, Danchuk version of 12-258 **24.90 R**
- 12-261 Bel Air, Includes 12-268, 70, 72, 73, 74, 75 Trim Parts **35.00 R**
- 12-261F Bel Air, Danchuk version of 12-261 **28.00 R**



12-269 **12-271** **12-270** **12-276**

55-6 Dash Control Indicator PLASTICS ONLY

Black/White letters EACH **8.70 R**

- 12-268 'Lock-Off-On-Start' 12-270 'Windshield Wiper'
- 12-272 'Lighter' 12-273 'Lights'
- 12-274 'Volume' 12-275 'Selector'
- 12-269 'Lock-Off-On-Start' Clear/white letters, '150'-'210' **8.70 R**
- 12-271 'Windshield Wiper' Clear/white letters, '150'-'210' **8.70 R**
- 12-256 'Rear Speaker' Black w/white letters **24.90 R**

55-6 Dash Control Indicators w/ Chrome

BACKPLATES EACH 12.50 R

- 12-276 'Lock-On-Off-Start' 12-277 'Windshield Wiper'
- 12-278 'Lighter' 12-279 'Lights'
- 12-280 'Volume' 12-281 'Selector'
- 12-257 'Rear Speaker' Black w/white letters **30.95 R**

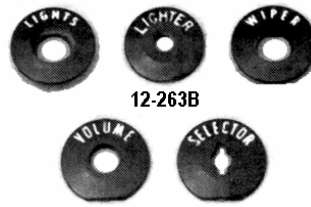

12-263B

57

Dash Control Indicators

EACH **10.30 R**

- 12-282 'Wiper' 12-283 'Lights'
- 12-284 'Lighter' 12-285 'Volume'
- 12-286 'Selector'

57 Dash Control Indicator Sets

- 12-263A 57 SET of 5 (USA, Trim Parts) **44.00 R**
- 12-263B 57 SET of 5 (Danchuk) **29.90 R**
- 12-263F 57 SET of 5 [Cal Classic] **17.50 RF**

- 12-262 57 'Rear Speaker' Indicator Each **20.25 R**

Dash CONTROL BEZELS

57 Set of 5 angled chrome bezels for lights, lighter, radio (2), wiper control

- 12-046 **69.50 R**



12-046

57 Ign Switch Chrome Bezel w/clip

- 12-343 'Off-On-Lock-Start' **14.90 R**
- 12-343D 'Off-On-Lock-Start' [Danchuk] **18.00 R**



12-343D

Ignition Switch NUT

- 12-396 55-6, chrome **16.80 R**
- 12-489 57 **12.00 R**



12-396

12-489

See GROUP 29 Stock & Custom Gauges, Gauge Faces, Trans Gear Indicators ETC. **page 223**



- 30-DBK556P DASH BEZEL KIT, 3 Rings & 2 Knobs 55-6 Billet **149.00**
- 30-RBK556P RADIO BEZEL KIT, 2 Rings & 2 Knobs 55-6 Billet **97.00**



30-DKN57

30-IHVK556

- 30-DKN57 DASH KNOBS 57 Billet set/3 **63.00**
- 30-IHVK556P Billet VENT KNOB KIT 2 Knobs 55-6 **43.00**

Instrument Panel Bezels & Trim

12-020A1 Upper Molding Only



12-020 7 pc set 3 rings & 4 housings

- 12-020 INSTRUMENT CLUSTER BEZEL SET, 57 Bezel Rings for speedo, gas & temp. gauges, 4 Light Housings gen., oil, signals **96.00 R**
- 12-020-D INSTRUMENT CLUSTER BEZEL SET, 57 Danchuk **109.00 R**
- 12-020A1 Discontinued Use 12-020A1F below
- 12-020A1F Upper Molding that trims cluster to the dash, chrome **49.90 RF**

- 20-566B Instrument CLUSTER MOUNTING KIT 57 includes upper column area to dash screws **4.40 R**
- 20-566 Instrument CLUSTER SCREWS, small screws to assemble gauges & support brackets to dash instrument cluster housing 21 pc set 55-6 **3.80**
- 20-566A Instrument CLUSTER BEZEL SCREWS, 55-6 Set **3.60**
- 20-581 SCREW & STAR WASHER Column chrome bottom cover to column bracket Rp. phillips head 55-6 **1.80**



12-068

55-6 Instrument Cluster Chrome

SPEEDO & CLOCK HOUSING SET includes chrome housings, speaker grill attached, upper & lower column chrome trim, USA, Set/4 \$ **439.00 R**

- 12-068 Stick Shift 12-069 Automatic

- 12-068A SPEEDO CHROME HOUSING, only Stick **195.00 R**
- 12-069A SPEEDO CHROME HOUSING, only Auto [has slot] **195.00 R**
- 12-085 CLOCK/SPEAKER HOUSING w/Screen, Chr. **195.00 R**
- 12-086 COLUMN CHROME TRIM PIECES, above & below column to instrument bezel. Pr. **150.00 R**

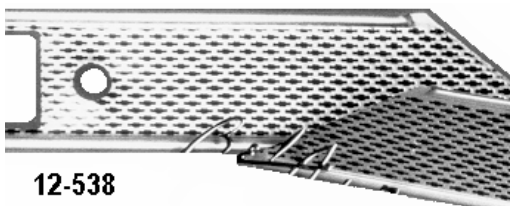

12-538

Stock 3 piece set, pressed pattern & painted Dash script not included.

55-56 Original Dash Trim Sets

- 12-538 55, Bow Tie' pattern G Smith **189.00 R**
- 12-538D 55, Bow Tie' pattern Danchuk **215.00 R**
- 12-539 56, Line pattern, G Smith **189.00 R**
- 12-539D 56, Line pattern, Danchuk **215.00 R**

Variations available in Stock Dash Trim 3 pc set Call for others

- 12-538NH 55 DASH TRIM No holes at all **195.**
- 12-538NHL 55 DASH TRIM No holes for lighter & radio **189.**
- 12-538NR 55 DASH TRIM No holes for radio only **189.**
- 12-539NH 56 DASH TRIM No holes at all **195.**
- 12-539NHL 56 DASH TRIM No holes for lighter & radio **189.**
- 12-539NR 56 DASH TRIM No holes for radio only **189.**



12-540D

57 Original Dash Trim Sets

- 12-540 57, Stock G Smith, script not included **199.00 R**
- 12-540NR 57, No radio holes, w/Script holes G Smith **199.00 C**
- 12-540NRS 57, No radio holes, No Script holes G Smith **199.00 C**
- 12-540D 57, Stock Danchuk, script included **226.00 R**
- 12-540DNR 57, No radio holes, w/Script holes Danchuk **215.00 R**



12-238

12-397

'Bel Air' Dash Scripts

- 12-238 55-6 dash speaker grill w/clips, gold **9.25 RF**
- 12-238B 55-6 dash speaker grill w/clips, gold, best quality **15.40 R**
- 12-397 57, on dash trim Ea. [Cal Classic Chevy] **10.75 R**
- 12-397A 57, on dash trim Ea. [Gene Smith best Quality] **14.50 R**

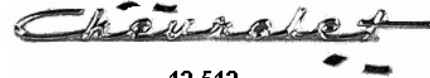

12-512

- 12-238A 'Chevrolet' Dash speaker grill Script 55-6, 210/150. Ea. **16.00 R**
- 12-512 'Chevrolet' Dash Script, 57 210/150's, chrome **16.50 R**

- 20-580A DASHBOARD FASTENER KIT, 55-6 All the screws & J nuts to assemble dash trim dash cluster bezels & column to dash. **7.00 R**
- 19-256B SPEAKER GRILL STUDS 57 for stock dash grill **9.00 RP**
- 20-004B DASH END CAP SCREWS, chrome, 57 Pr. **1.00 R**

Billet Aluminum Dash Trim

Ball mill design polished finish, 3 pc sets Back Roads Fabrication USA

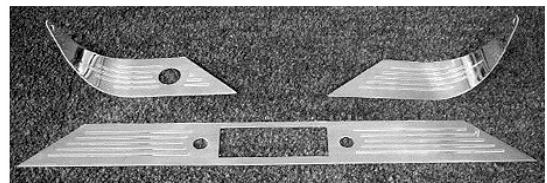

12-538A

- 12-538A 55-6 with stock radio opening **239.00 C**

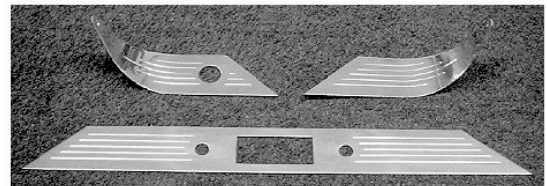

12-538A1

- 12-538A1 55-6 with CustomAutoSound radio opening, radio fits in trim without their filler bezel **239.00 C**

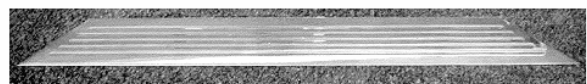

12-538B1

- 12-538B1 55-6 No radio holes Milled Lines only 3pc **239.00 C**

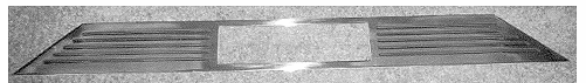

12-538E1

- 12-538E1 55-6 with CD CUTOUT 2" x 7-1/4" 3pc **239.00 C**

57 Sets now include long nut for headlight switch.

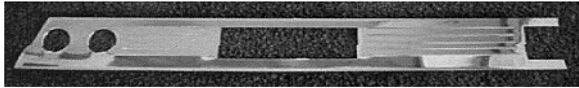

12-540E1

12-540C 57 with CD CUTOUT 2" x 7-1/4" all 3pc **299.00C**

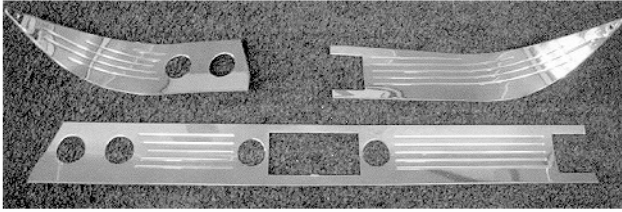

12-540A

12-540A 57 stock radio holes **299.00C**

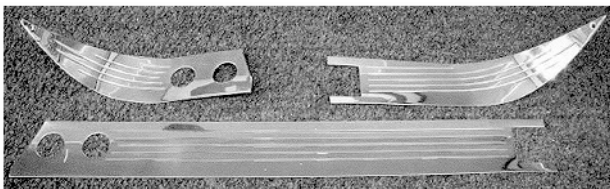

12-540B

12-540B 57 No radio holes **299.00C**

Grp 14A **Pedals and Pads**

14-100



14-101



14-107

- 14-100 PEDAL PAD, Clutch or Brake pedal, all except automatic with power brakes. Rubber, Ea. **9.85 R**
- 14-100F PEDAL PAD, Clutch or Brake pedal, Ea. **6.50 RF**
- 14-101 PEDAL PAD, Power Brake auto trans. Rubber, Ea. **21.00 R**
- 23-106 Gas Pedal & Dimmer Switch CARPET GROMMETS, trims carpet they come thru. Pr. **18.00 R**
- 23-102 Dimmer Switch CARPET GROMMET only. Each **6.00 R**
- 14-107 Gas Pedal LINKAGE BUSHING (thru Firewall), 2 required, ea. **1.50 R**



14-102D



14-106

- 14-102D GAS PEDAL, includes 14-105 [Danchuk] **32.00 R**
- 14-102F GAS PEDAL, includes 14-105 [Fargo] **27.90 R**
- 14-105 Gas Pedal PLASTIC INSERT, fits on back of pedal, makes contact w/ accelerator linkage Lever **2.50 R**
- 14-106 Gas Pedal ACCESSORY RUBBER COVER, w/integral circular heal pad, protects carpet **24.00 R**



Lokar Midnight Series

LOKAR GAS PEDAL Assembly

Billet direct fit bolts in stock location uses cable [drill cable hole in firewall] See Group 27 for cables **\$231.95**

- L-BAG6073 Billet plain ball mill
- L-BAG6074 Billet rubber inserts
- L-BAG6074X Black w/rubber inserts

- L-BAG6113 Billet w/rubber inserts 1" longer upper arm Big Block w/tall valve covers **\$244.95**
- L-BAG6113X All Black version of L-BAG6113 **\$244.95**
- L-GPS6016 Gas Pedal .5" SPACER to increase clearance **\$52.95**



LOKAR Eliminator Floor Mount Gas Pedal **\$244.95** See GROUP 27 for Throttle cables

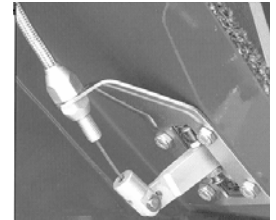

- Routes throttle cable from directly below pedal in toe panel. Designed with built in pedal travel stops. Requires 36" Lokar throttle cable [not included]
- L-FMG6097 Billet L-FMG6098 Billet w/rubber inserts
 - L-FMG6098X Black Billet w/rubber inserts

LOKAR BRAKE/CLUTCH Curved Pedal Pads



L-BAG6139



- L-BAG6139 Billet rubber inserts Pair **\$145.95**
- L-BAG6139X Black rubber inserts Pair **\$145.95**
- L-BAG6137 Power Billet rubber inserts **\$96.95**



L-BAG6137

LOKAR BRAKE/CLUTCH Flat Pedal Pad **\$68.95**

- L-BAG6075 Billet plain ball milled Each
- L-BAG6076 Billet w/rubber inserts Each
- L-BAG6076X Black w/rubber inserts Each



L-BAG6078

Power Brake Mount



L-BAG6079

LOKAR POWER BRAKE PEDAL Flat PAD **\$87.95**

- L-BAG6077 Billet plain ball milled Each
- L-BAG6078 Billet w/rubber inserts Each
- L-BAG6078X Black w/rubber inserts Each

LOKAR Standard BRAKE PEDAL Large Flat Pad **\$87.95**

- L-BAG6079 Billet plain ball milled Each
- L-BAG6080 Billet w/rubber inserts
- L-BAG6080X Black Billet w/rubber inserts

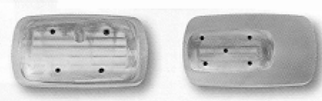

Back of BAG-6137 Back of BAG-6138

LOKAR Standard Brake Pedal Large Curved PAD \$96.95

- L-BAG6138 Billet rubber inserts
- L-BAG6138X Black rubber inserts

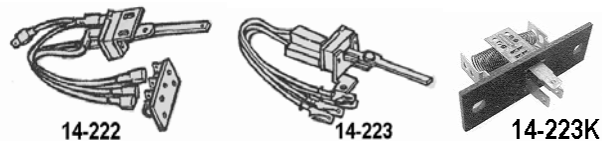

- 14-222 Heater FAN SWITCH 55-6 Deluxe Heater **41.00 R**
- 14-223 Heater FAN SWITCH 57 Deluxe Heater **49.00 R**
- 14-223K 57 Heater RESISTOR Kit replacement with
adapting harness **19.95 RP**



LOKAR 55-7 Billet PEDAL ARMS
Brake & Clutch w/ curved Pads
 Aluminum, Curved Direct Fit
 Brake Pedal only **\$283.95**

- L-BCA9511 standard Pad
- L-BCA9511X standard Pad, Black
- L-BCA9512 Power Brake Pad
- L-BCA9512X Power Brake Pad, Black

Brake & Clutch Pedals **\$567.95**

- L-BCA9513 Billet w/standard Pads
- L-BCA9513X Black Billet w/standard Pads

L-BCA9513

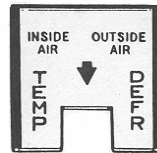

14-219

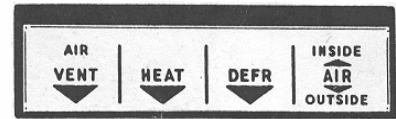

14-220

- 14-219 Heater CONTROL FACE 55-6 (Trim Parts) **28.00 R**
- 14-220 Heater CONTROL FACE 57 (Trim Parts) **28.00 R**



14-219A



14-112A



14-220A

- 14-130 CLIP, Heater Lever Shaft Pivot Pin Retainer, 55-6 **.50 R**
- 14-112A LEVER PIVOT PIN KIT, for 55-6 Deluxe heater control;
pin, retainer, spring, 2 washers **5.00 R**
- 14-219A Indicator face black BACKPLATE 55-6 Deluxe heater **3.00 R**
- 14-220A Indicator face black BACKPLATE 57 Deluxe heater **4.50 R**

Grp 14B

Heater Parts

Air conditioning page 214



14-112

14-113

STOCK HEATER CONTROL KNOBS

- 14-112 55-6 Deluxe Heater Lower Levers only Pair **7.00 R**
- 14-113 55-6 Deluxe Heater Set of 4, (Trim Parts) **13.00 R**
- 14-113F 55-6 Deluxe Heater Set of 4, (Fargo) **9.90 RF**



14-114F

- 14-114 57 Deluxe Heater Set of 5 (Trim Parts) **33.00 R**
- 14-114F 57 Deluxe Heater Set of 5 (Danchuk) **23.50 R**

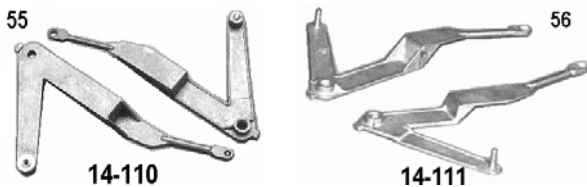

14-110

14-111

- 14-110 Heater LOWER LEVERS 55 Deluxe heater, Pr **21.90 R**
- 14-111 Heater LOWER LEVERS 56 Deluxe heater, Pr. **21.90 R**

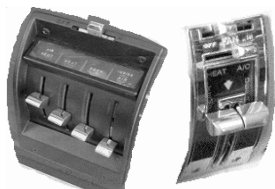

BILLET ALUMINUM HEATER CONTROL KNOBS

- 30-556HTK 55-6 Deluxe Heater Set of 4 **119.00 C**
- 30-57HTK 57 Deluxe Heater Set of 5 **125.00 C**

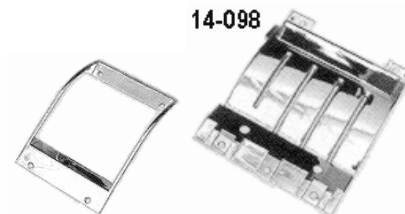

14-098

57 Heater Control BEZEL

- 14-098 57 Deluxe Heater FACE PLATE & BEZEL **145.00 R**

- 20-331B 57 Deluxe Bezel FASTENER KIT [included in 14-098A] **6.50 R**



14-099

- 55-6 Heater Control BEZEL
- 14-099 Deluxe 4 Knob heater, Chrome **99.00 R**



14-120B

- 14-120B AIR VENT SET 6 pc 2 Doors, 2 Grills, 2 Cables [Deluxe Heater] 55-6 [comes with 56 style ribbed knobs only] **146.00 RPF**



14-122B Air Duct GRILLS, 57 Pr. underdash [Call for used] **88.00 RF**



VENT CABLES
14-120A smooth knobs, 55 Pr. **61.00 R**
14-121A ribbed knobs, 56 Pr. **61.00 R**
14-122A VENT CABLE, 57 standard heater, Each **33.00 R**

Vent Cable to Dash Screws
20-502S Original Clutch Heads Set/4 55-6 **5.50 R**
20-502RP Replacement Phillips Head 55-6 8pc Set **3.00 RP**

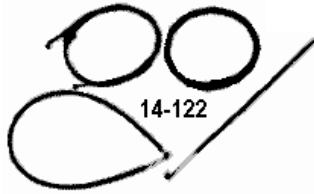

Heater CONTROL CABLES

- 14-120** Deluxe Heater, 55 set/3 **32.00 R**
- 14-121** Deluxe Heater, 56 set/3 **32.00 R**
- 14-122** Deluxe Heater, 57 set/4 **41.00 R**
- 14-148** Heater & Orig. Air Conditioning, 57 set/6 **99.95 R**
- 14-148A** Heater & Orig. Air Conditioning, 55 set/4 **59.90 R**
- 14-148B** Heater & Orig. Air Conditioning, 56 set/4 **59.90 R**
- 14-216** Cable Retaining CLIPS, 57 for left and right fresh air duct doors **4.00 R**



14-097A 14-097B 14-097C

55-7 Heater Cable Clamp usage.

<u>Straight Tab Single</u> [14-097B]	<u>Offset Tab Single</u> [14-097C]
55-6 deluxe dash control 2	57 deluxe dash control 4
55-6 deluxe control valve 1	57 deluxe control valve 1
57 deluxe defroster lever 1	
56-7 standard heater defrost lever 1	
55-6 outside air door lever 1	

All clips below made in USA, proper heat treat & zinc plated.

- 14-097A** CABLE CLIP Double 55-6 Deluxe Heater Control Ea. **8.80 R**
- 14-097B** CABLE CLIP Straight Tab Single 55-6 Deluxe Heater Control, 56-57 defroster lever on heater box Ea. **7.70 R**
- 14-097C** CABLE CLIP Offset Tab Single 57 Deluxe Heater Control, Ea. **7.70 R**
- 14-097AS** CABLE CLIP SET/5 55-6 Deluxe Heater 4 straight tab, 1 double cable, with screws. **32.90 R**
- 14-097CS** CABLE CLIP SET/4 57 Deluxe Heater Control 4 offset tab with screws **27.50 R**
- 14-097CS2** CABLE CLIP SET/6 57 for Deluxe Heater, 5 offset tab, 1 straight tab w/screws. **39.50 R**
- 14-128** 55 HEATER CABLE SET SCREW, cable to control lever, ea. **.60 R**
- 14-128A** Push-On Flat NUT for Heater Cable Door plain 5/32

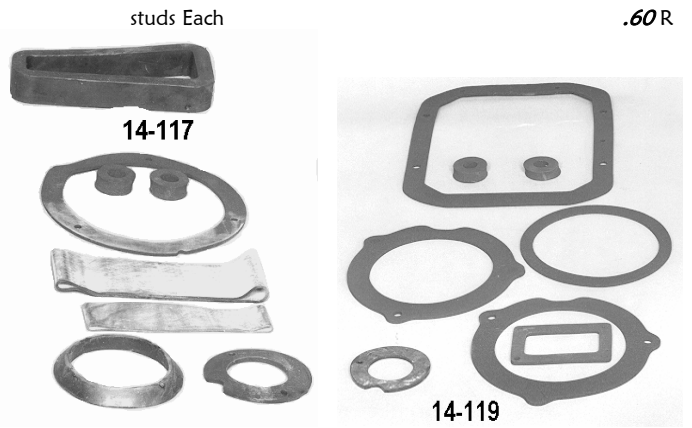

HEATER GASKET SETS
14-116 55-6 Standard heater (single knob control) **23.00 R**
14-117 55-6 Deluxe heater (4 knob control) **23.00 R**
14-118 57 Standard heater (2 knob dash control) (includes firewall air duct seals) **19.90 R**
14-119 57 Deluxe heater (5 knob dash control) (includes firewall air duct seals) **19.90 R**



14-143 **14-123** Blower MOTOR SLEEVE, 57, fits square duct opening **6.75 R**
14-143 SEAL Heat/Defrost Square Duct, 57 **12.50 R**



Heater Box Fastener Kit
 Screws, nuts, washers & spacers for assembly
20-331A 55-6 41pc **8.00 R**
20-331 57 26pc **7.50 R**

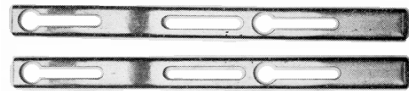

14-182 Heater BOX RETAINERS, 57 w/deluxe heater, pr., 2 long brackets that hold air box cover to firewall **35.00 R**
14-182A Heater BOX Retainer PIN Assembly on a plate as original were welded to firewall on the inside. Each **10.00 R**



14-199 Heater Fan Housing to Inner Fender BRACKET, 57 w/deluxe heater **11.00 R**



SEALS, Air Duct to Inner Fender
 fits edge of inner fender where duct goes thru
14-124 not molded 57Pr. **11.00 R**
14-124A molded, 57 Pr. *N/A Use 14-124*



Air Duct Inlet FLEXIBLE HOSE, 57
14-215 Cloth **12.00 R**



Fresh Air Inlet SLEEVES 57 Pr.
14-126 non-molded **12.50 R**
14-126A molded version *N/A Use 14-126*



14-127A

14-127A
AIR DUCT, 57
Each
239.00 RF



14-127

14-127T Air Duct DRAIN TUBE, 57, Ea. **16.00 R**

14-127TS Drain Tube SCREWS set/4 w/star washers phillips pan head screws 57 **2.00 Rp**

14-127 Drain Tube GROMMETS 57, pr. **2.00 R**



14-127T

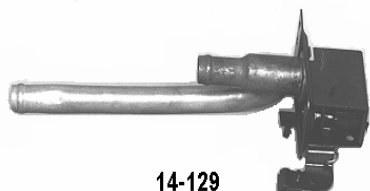

14-129

14-129
Heater CONTROL VALVE 55-56 deluxe heater **74.90 R**

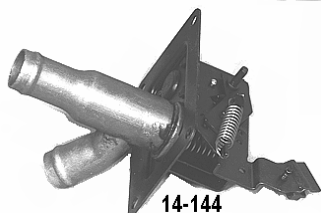

14-144

14-144
Heater CONTROL VALVE 57 deluxe heater **95.00 R**

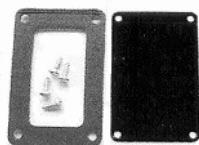

14-144A

14-144A Control Valve Block-Off PLATE w/gasket & screws **6.00 R**

14-144B Control Valve Plate GASKET only **1.75 R**

14-150B Heater Fan HOLE BLOCK-OFF Plate 57 cad plated **30.00 R**

14-150C Heater Fan HOLE BLOCK-OFF Plate 57 chromed **50.00 R**

V-64112VCB 57 Heater Delete/Firewall Block-Off PLATE steel **65.00 RP**

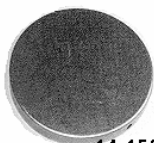

14-150B

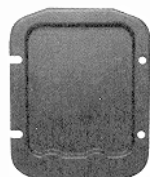

V-64112VCB



14-150

14-150 Heater FAN MOTOR ASSEMBLY, 55-6 with cage & new replacement fan motor, Exchange **95.00 RP**

14-150A Heater FAN MOTOR, 57, supplied without fan cage, replacement **68.00 RP**

20-009S HEATER FAN MOTOR SCREWS, 57, Set/5 original indented hex washer head w/marks. Black **3.00 R**



14-150A



14-155B

14-155B-1 Replacement Heater Box GRAY PAINT Spray Can **10.50 RP**

HEATER CORES

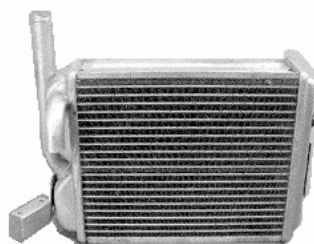

14-133A

14-133A

HEATER CORE 55-6 w/Deluxe heater, all Aluminum reproduction

\$133.00 R

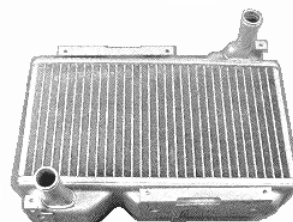

14-135A

14-135A

HEATER CORE 57 w/Deluxe heater, all Aluminum reproduction

\$133.00 R



14-133

Recorded Heater Core Exchange only send in your used core FIRST **\$250.00**

14-132 55-6 standard heater

14-133 55-6 deluxe heater

14-134 57 standard heater,

14-135 57 deluxe heater

HEATER HOSE SETS



17-216

Original hoses are both 5/8" in 55-6, both 3/4" on 57 [w/deluxe heater]
Standard Heaters are 5/8" hose on both

GM marks on Original Ribbed Hose set **\$40.00 R**

17-215A 55-6 6 cyl

17-216 57 V8 Deluxe Heater

17-216A 57 6 cyl Deluxe Heater

17-216B 57 V8 w/AC

17-215 55-6 V8, 57 w/Standard Htr

Plain Original Ribbed Hose set **\$34.00 R**

17-215AR 6 cyl 55-6, 57 w/Std Htr

Plain Original Ribbed Hose set **\$34.00 R**

17-216BR 57 V8 w/AC

17-217EA 5/8 Heater Hose, by the foot, Black **1.75 RP**

17-218EA 3/4 Heater Hose, by the foot, Black **1.85 RP**



14-131A



14-217



30-3610



30-3609

Heater HOSE BRACKETS

14-131A 57, screws to bottom of battery box **5.00 R**

14-217 55-6 to Inner Fender 2 pc as original to hold hoses to inner fender **12.00 R**

30-3610 Plain polished Stainless **23.00 C**

30-3609 Slotted polished Stainless **23.00 C**

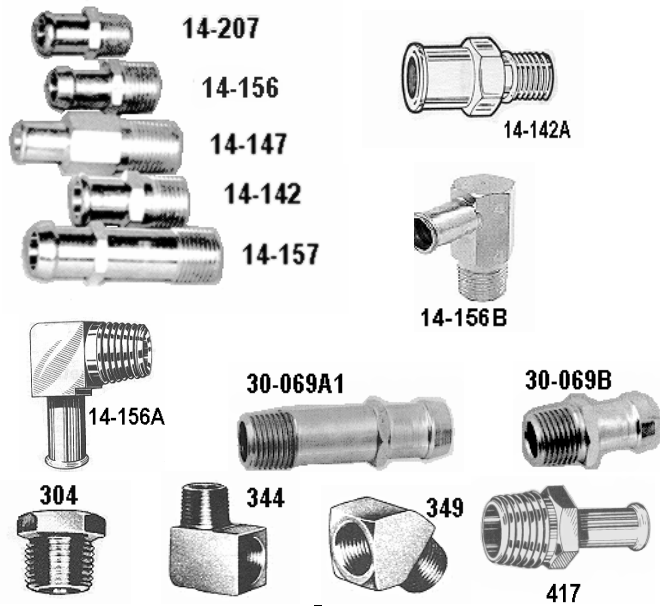

HEATER HOSE NIPPLES

- 14-156 Short for 5/8" hose, 55-6 V8 intake, 1/2" NPT **8.50 R**
- 14-142 Short for 3/4" hose, 57 V8 intake, 1/2" pipe NPT **8.80 R**
- 14-142A Short for 3/4" hose, has smaller 3/8 NPT pipe end **9.50 C**
- 14-207 Short for 5/8" hose, 6 cyl. thermostat housing, Also on some 55 V8 intakes w/ 5/8" dia. Hole 3/8" pipe NPT [use 14-156 on intakes with 13/16" dia. hole] **8.80 R**
- 14-147 Long for 5/8" hose, 55-6 water pump 1/2 NPT **9.90 R**
- 14-147A Long for 5/8" hose, Stainless Steel 1/2 pipe NPT **22.00 C**
- 14-157 Long for 3/4" hose, 57 water pump, 1/2" NPT **12.90 R**
- 14-207A Long for 5/8" hose, some 55 V8 water pump, 6 cyl water pump 3/8" pipe thread NPT **10.65 C**

- 14-156A 90° for 5/8 hose, 1/2" pipe thread, brass **9.75 C**
- 14-156B 90° for 5/8 hose, 1/2" pipe thread, zinc steel **12.90 C**
- 14-207B 90° for 5/8 hose, 3/8" NPT [Looks like 14-156A] brass **8.80 C**

- 30-069A1 Long, Chrome ea. 3/4" hose **9.50 C**
- 30-069B Short, Chrome ea. 5/8" hose **7.50 C**

Brass Bushings NPT external Male, internal Female

- 303 Hex Hd 1/2 pipe external to 1/4 pipe internal **4.20**
- 304 Hex Hd 1/2 pipe external to 3/8 pipe internal **3.50**

- 362 Brass Vertical T 1 male 2 female 1 male 1/2 NPT 2 female 1/2 in the side, & 1 in the top **25.00**
- 344 Elbow 90° 'street' 3/8 pipe thread 1 Male 1 Female end **8.75**
- 349 Elbow 45° 'street' 3/8 pipe thread 1 Male 1 Female end **9.75**
- 463 Beaded 5/8 id Hose 90° Nipple 3/8 NPT male Brass **9.50**
- 416 Beaded 5/8 id Hose strait Nipple 3/8 NPT male Brass **5.00**
- 417 Beaded 5/8 id Hose strait Nipple 1/2 NPT male Brass **7.00**
- 418 Beaded 3/4 id Hose strait Nipple 1/2 NPT male Brass **7.50**



17-144

- 17-144 5/8" heater hose original style Spring Clamp, ea. **.95 R**
- 17-145 3/4" heater hose original style Spring Clamp, ea. **2.50 R**
- 9585 Stainless Worm Clamp .5-1.25", for 5/8" Heater Hose **3.00**
- 9586 Stainless Worm Clamp .5-1.25", for 3/4" Heater Hose **3.50**

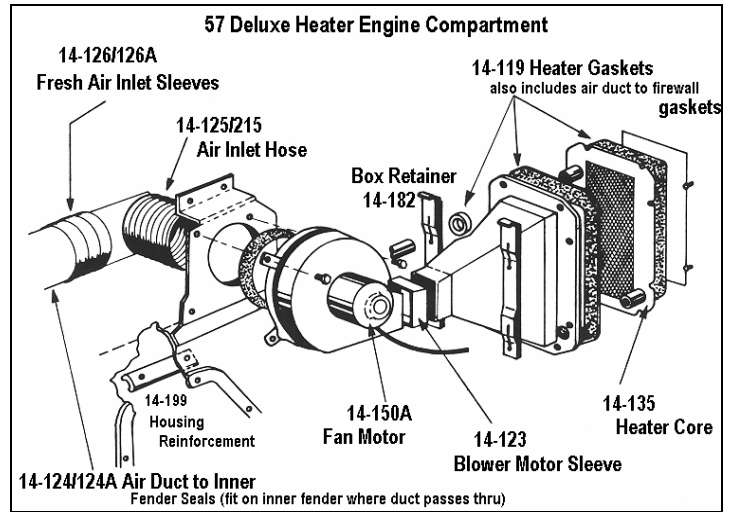

Grp 15

Clutch

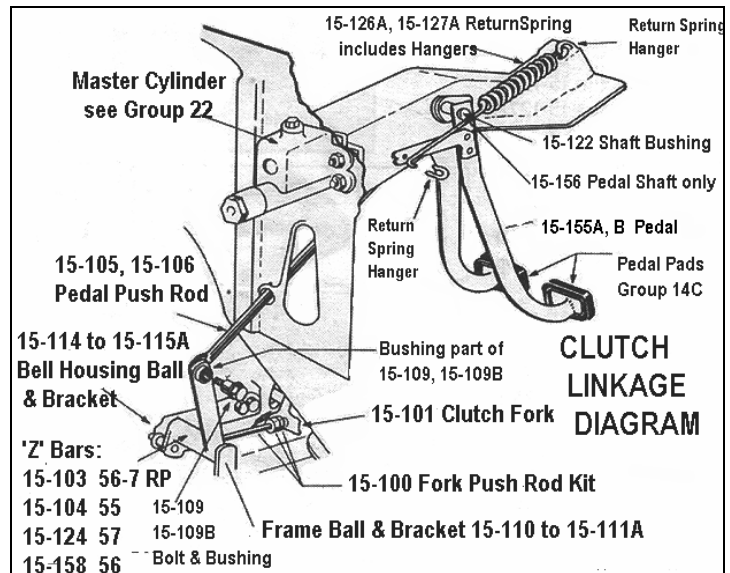

15-100

- 15-100 FORK PUSH ROD KIT, 57 (will fit 55-56 if 15-101 clutch fork used) USA Made by us. **25.00**
- 15-100B Fork Push ROD Only **18.00 R**
- 15-100C Fork Push Rod SPRING Only **6.00 R**
- 15-100D Fork Push Rod SWIVEL Only **14.00 R**
- 15-100-DAN FORK PUSH ROD KIT, 57 (will fit 55-56 if 15-101 clutch fork used) Danchuk. **24.65**

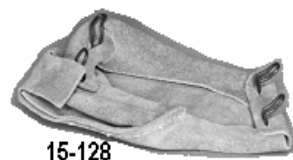

15-128

- 15-128 Clutch Fork Leather BOOT, 55-6, on Bell Housing (3 7/8" diagonal across holes) housing cast #3704922 **22.50 R**
- 15-129 Clutch Fork Leather BOOT, 57, on Bell Housing (4 1/4" diagonal across holes) housing cast #3733365 **22.50 R**



15-101



15-102A

- 15-101 Clutch FORK, 57 (use on 55-6 w/15-100) **85.00 R**
15-102A FORK BALL STUD 57-69 (screws into bell from outside in) Bell Housing #3733365 **14.80 R**

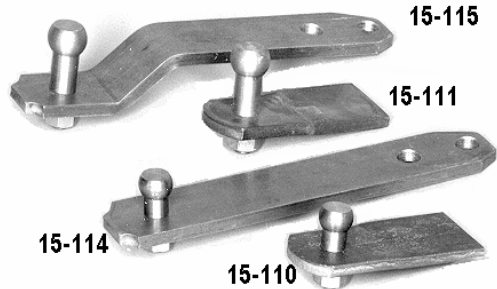

15-115

15-111

15-114

15-110

Z BAR
BALL &
BRACKET

- 15-110 FRAME, 55 w/screw on ball **22.00 RP**
15-110A FRAME, 55 w/ welded on ball **19.00 R**
15-114 BELL HOUSING, 55 w/screw on ball **31.00 RP**
15-114A BELL HOUSING, 55 w/ welded on ball **28.90 R**
15-112 Z BAR Pivot BALL STUD ONLY, 55, threaded **19.90 RP**
15-111 FRAME, 56-7 w/screw on ball **22.00 RP**
15-111A FRAME, 56-7 w/ welded on Ball **19.00 R**
15-115 BELL HOUSING, 56-57 w/screw on ball **18.90 RP**
15-115A BELL HOUSING, 56-57 w/welded on ball **28.90 R**
15-113 Z BAR Pivot BALL STUD ONLY, 56-57, threaded **19.90 RP**

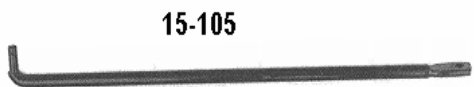

15-105



15-143

Clutch Pedal **PUSH ROD** (pedal to 'Z' bar thru firewall)

- 15-105F 55-56 foreign **14.00 RF**
15-105-1 55-6 NOS USA **30.00 R**
15-106F 57 foreign **13.50 RF**

- 15-143 ANTI-RATTLE SPRING, fits under cotter pinned linkages, clutch pedal push rod, kick downs, shift rods Each. **2.30 R**
20-339 BOLT SET Manual Trans to Bell Housing, 8 pc **5.50**
20-347 BOLT SET Rr Motor Mounts to Bell Housing Manual cars w/lock washers 16 pc **5.80**
20-446 BOLT SET Bell Housing to Engine, Manual V8 w/locks. 14 pc **5.50**



15-119-2

CLUTCH BELL HOUSING BRACKET for cars with non stock

Aluminum Bell Housing.

Bolts to bell housing mounting to block. Includes the correct ball for the year. **\$69.00**

Replaces 15-115B Made in USA

- 15-119-1 55 small ball w/ strait bracket
15-119-2 56-7 large ball w/ bent bracket

WW260-10372 Wilwood compact Master Cylinder 3/4" bore Single 1/8 npt outlet port coated aluminum body, plastic reservoir 7 oz & 10 oz w/hose & clamps. 1.12" stroke [for hydraulic clutch] **\$111.00**



15-104

15-124

15-103

**CLUTCH CROSS
SHAFT (Z Bar)**

- 15-104 55 Original [made in USA by us] **43.00**
15-158 56 Original [made in USA by us] **36.00**
15-124 57 Original [made in USA by us] **36.00**

15-103 56-57 Replacement style **34.00**



15-120

Part of
15-109B

Part of
15-109 & 15-109B

15-144

SHOULDERED BOLT & BUSHING, Z bar connection to pedal rod

- 15-109 Shoulder Bolt w/replacement plastic bushing **19.90 RP**
15-109A Shoulder Bolt Assy. Only Replacement **8.00 RP**
15-109B Shoulder Bolt w/original rubber/metal bushing **16.00 R**
15-109C Rubber Bushing Only **9.00 NOS**
15-120 Z Bar FELT WASHER, for ball studs, ea. **1.95 RP**
15-144 Pedal Push Rod FELT GROMMET Firewall **8.00 R**

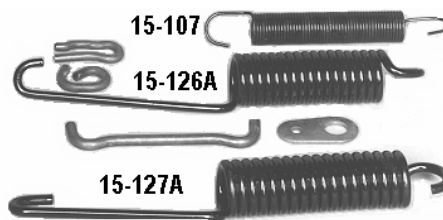

15-107

15-126A

15-127A

- 15-107 Pedal Lower **PULL BACK SPRING**, 55 on adjustment rod, also replacement for other years **N/A**
15-126 Pedal **RETURN SPRING**, 55-56 under dash w/hangers **17.00 RF**
15-126A Pedal **RETURN SPRING**, 55-56 under dash w/hangers **37.00 R**
15-127 Pedal **RETURN SPRING**, 57 under dash w/hangers **18.00 RF**
15-127A Pedal **RETURN SPRING**, 57 under dash w/hangers **37.00 R**
15-157 **SPRING HANGER BRACKET**, 57 bolts to clutch pedal **27.00 U**
15-157A **SPRING HANGER BRACKET**, 57 bolts to clutch pedal **15.00 R**
15-118A Clutch Pedal Return Spring **HANGER PLATE**, 57 ea **4.00 R**
15-118B Clutch Pedal Return Spring **HOOK**, 57 ea **4.50 R**

CLUTCH PEDAL

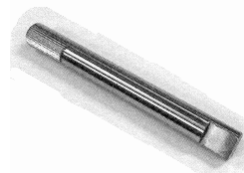

15-156

15-156

Clutch Pedal **SPLINED SHAFT**. To repair your existing pedal. High quality USA made **45.00 R**



15-155B

Reconditioned Pedals

Exchange, your pedal. Made with high quality USA made splined shaft installed **\$95.00 R**

- 15-155A Clutch Pedal with New Shaft Exchange. 55-6 Ea.
15-155B Clutch Pedal with New Shaft Exchange. 57 Ea.



15-122PR

15-122PR Pedal SHAFT BUSHING, plastic, on shaft as it passes thru dash support, (clutch pedal) pr. **5.50 R**

15-125 Pedal STOP BUMPER & BRACKET, 55-56 **10.75 R**

15-161 Pedal SPACER BUSHING, fat washer on shaft **4.50 R**



15-125

15-161

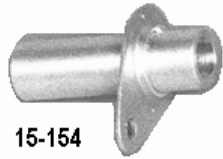

15-154

15-154
PIVOT SLEEVE, for clutch pedal in the dash support **17.80 R**



15-116

15-116
Pedal Shaft SPLINED LEVER, connects pedal to push rod under dash. Precision now made in USA **24.00 R**



15-150S

15-150 Flywheel BOLT to Crank, Stick Ea. **3.50**

15-150S Flywheel BOLT, to Crank SET/6 **18.90**

15-152 STAR WASHER, external tooth flywheel to crank Ea. **.25**



15-153S

15-153 Pressure Plate BOLT to Flywheel, Ea. **4.00 R**

15-153S Pressure Plate BOLT, to Flywheel, SET/6 **18.90 R**



15-162A

15-162 PILOT BUSHING, Stick Trans in Crank powdered metal **8.00 R**

15-162A Roller Pilot Bushing replaces original brass bush that are no longer made in brass. Recommended for high performance. **25.00 C**

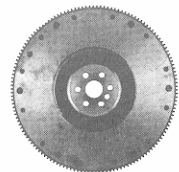

28-122B

FLYWHEEL V8 Stick Shift
28-122B Small Block with 2 pc rear main seal. 168 tooth uses 11" clutch not for orig. 10.5" pressure plate **135.00 RP**
See Group 28 or call for others

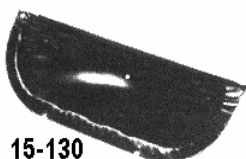

15-130

15-130 Bell Housing BOTTOM DUST COVER, V8 **45.00 R**



15-131

15-131 Bell Housing FRONT DUST SHIELD, V8 **20.00 R**



15-146

15-145

15-141A

15-145 THROW-OUT BEARING, long style **49.00 R**

15-146 THROW-OUT BEARING, short style **39.00 R**

15-146A THROW-OUT BEARING, short style Centerforce **54.00 C**

PRESSURE PLATE & DISC SETS

New technology plate, disc & bearing, New, not rebuilt, low pedal pressure, Includes Pressure Plate, Disc and Bearing

15-141A **10.5"**, fits all original '6' & V8, most custom applications (10 tooth **coarse spline**) **235.00 R**

15-141B **10.5"**, fits all original '6' & V8, most custom applications (26 tooth **fine spline**) **235.00 R**

15-142A **11"**, (10 tooth **coarse spline**) use with #28-122B Flywheel **225.00 R**

15-142B **11"**, (26 tooth **fine spline**) use with #28-122B Flywheel **235.00 R**

15-142C **11"** Plate & Disc w/10 tooth coarse spines [Centerforce] light pedal pressure, best quality **474.00 C**

15-142D **11"** Plate & Disc w/26 tooth fine spines [Centerforce] light pedal pressure, best quality **504.00 C**

Grp 16A Windshield Wipers

Our Most Popular Arms & Blades!



16-102

16-101L

16-101R

Flat Type End

Wiper Arms

16-101L Left, polished has **flat style** blade end **28.00 RPF**

16-101R Right, polished has **flat style** blade end **28.00 RPF**

Wiper Blade

16-102 Polished, for 16-101L & 16-101R ea. **19.50 RPF**

16-101S WIPER SET, 2 #16-102 blades 1 each #16-101L & #16-101R, set of 4 **89.00 RPF**

Hook Type End

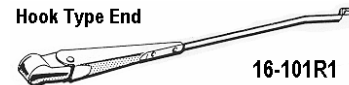

16-101R1

Wiper Arms

16-101L1 Left, polished, has **hook style** blade end **14.00 RPF**

16-101R1 Right, polished, has **hook style** blade end **14.00 RPF**

16-102A

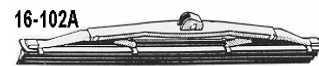

Wiper Blade

16-102A Polished, for 16-101L1 & 16-101R1 ea. **15.50 RPF**



Wiper Arms Original

Chrome & polished stainless as original, a beautiful repro,

- 16-101A** 55-6 w/Vacuum Motor, 55 & 56 replacement w/Electric motor Pr. (use w/16-102A or 16-001 blades) **45.00 R**
- 16-101B** 57 w/Vacuum Motor, Pr. (use w/16-102A or 16-001) **45.00 R**
- 16-101D** 57 w/Electric Motor, Pr. (use w/16-102 blades) **45.00 R**



- 16-001** Wiper Blade 55 electric & vacuum; 56-7 vacuum motor ORIGINAL, only, pr. (use with 16-101A & B arms) **N/A** use 16-102A



- 16-098** Chrome WIPER SAVERS, these fit over transmissions in place of wiper arms, if wipers not to be used Pr. **15.00 C**



- 16-145A** Wiper Transmission SPACERS 55-6 Pr **19.00 R**
- 16-145AU** Wiper Transmission Used SPACER 55-6 Each **7.00 R**
- 16-116** Wiper ESCUTCHEON NUT, chrome, ea. **3.25 R**
- 16-116T** Wiper Escutcheon NUT TOOL **17.50**



Wiper Bezels see Page 57

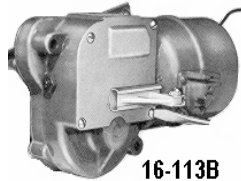

Electric Wiper Motors *Exchange only*

We must have EXCHANGE before we can send you one. **\$179.00**

- 16-113A** 55, rebuilt /restored, 1 year guarantee
- 16-113A1** 56, rebuilt /restored, 1 year guarantee
- 16-113B** 57, rebuilt /restored, 1 year guarantee
- 16-135A1** On/Off CABLE Holddown PLATE, Electric Wiper Motor 57 flat style, original **15.00 R**
- 16-095** Wiper Motor & Drive MOUNT SCREWS, vacuum & electric **3.50 R**
- 16-095A** Original Wiper Motor Control Cable Screw & Washer **1.00 R**



- 16-104** Wiper DRIVE SEALS, from drive to firewall **3.90 R**



- 16-134** Wiper ACTUATOR ADAPTER, 55-6 w/elec. motor to adapt vacuum washer option, ea. **8.00 R**
- 16-111** Wiper Motor ACTUATOR, 57 w/electric motor **6.95 R**
- 16-111A** Wiper ACTUATOR ADAPTER, 57 electric motor w/washers **12.00 R**
- 16-133** Wiper Motor ACTUATOR, 55-6 w/electric motor **7.50 R**



Wiper Transmissions Rebuilt

We must have EXCHANGE before we can send you one. **\$59.00** Each

- 16-144** 55-6 Left **16-145** 55-6 Right
- 16-146** 57 Left **16-147** 57 Right

- 16-146NOS** Wiper Transmission 57 Left. Ea. NOS **70.00**

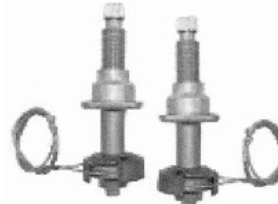

16-145PR



16-147PR

- 16-145PR** Wiper TRANSMISSIONS 55-6 PR Reproduction **225.00 RF**
- 16-147PR** Wiper TRANSMISSIONS 57 PR Reproduction **225.00 RF**



16-103

- 16-103** Washer NOZZLE, in wiper escutcheon, Ea. Only fits foreign made bezels **Discontinued**



16-103A

- 16-103A** Wiper ARM RIVETS, pr. **3.50 R**



16-2357

Electric Wiper Motor Cover Plate

part # & orig. markings **\$35.00** Each R

- 16-2157** 55, **16-2257** 56 **16-2357** 57
- Discontinued Discontinued

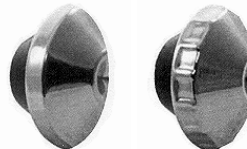

16-099B

16-099C

Wiper Control Knobs R

- 16-099A** 57 Bel Air & 210' **15.50**
- 16-099B** 55 Bel Air **14.00**
- 16-099B1** 55 Bel Air **15.00**
- 16-099C** 56 Bel Air **14.00**
- 16-099C1** 56 Bel Air **15.00**

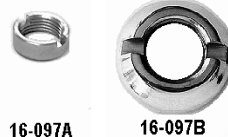

16-097A

16-097B

Wiper Switch NUT to dash

- 16-097A** 57 Ea. **4.00 R**
- 16-097B** 55-6 Ea. **11.00 R**



16-114A

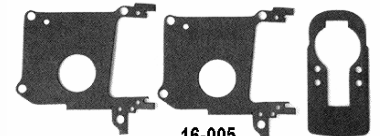

16-005

Wiper Control Cable

'RB' is Exchange only we must receive core before shipping out

- 16-114A** 55 **REBUILT** Exchange only **79.00 RB**
- 16-114B** 56 **REBUILT** Exchange only **79.00 RB**
- 16-114N** 55-56 Repro except 55 w/washers **79.00 R**
- 16-115C** 57 Repro w/stainless cable **79.00 R**
- 16-005** Trico Vacuum WIPER MOTOR GASKETS **7.50 R**

'RAINGEAR' Lever & Link Custom Wiper Drive System

Comes with 2 speed motor and fits entirely under the dash; no modifications to body. On some installations minor mods on dash support rods are necessary. Has cover plate for original wiper motor holes. New wiper switch mounts in original location & uses original knob & bezel, Includes Motor, does not include blades or arms. All Units work with Vintage Air AC kits.

<u>16-085</u>	55-6 Standard	516.95
<u>16-086</u>	55-6 w/'Delay'	577.95
<u>16-087</u>	57 Standard	577.95
<u>16-088</u>	57 'Delay'	637.95
<u>16-089</u>	Washer Option, kit	109.95

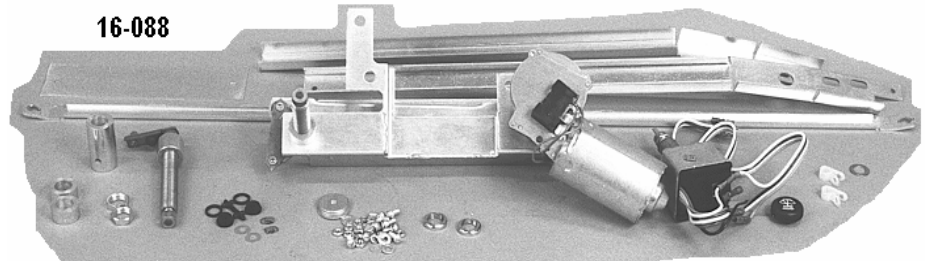

We can also get for you all other Systems made by Raingear this includes: 53-54 Chevy, 47-54 & 55-9 Chevy Trucks, 53-62 Corvette, 67-81 Camaro, 64-67 Chevelle, Ford products etc. CALL!

Group 17A Lens & Lens Gaskets

55

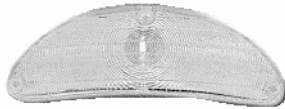

17-104



17-121

<u>17-104</u>	Park Light LENS Clear, 'Guide', Ea.	7.50 R
<u>17-104TP</u>	Park Light LENS Clear, 'Guide' USA [Trim Parts] Pr.	15.00 R
<u>17-105</u>	Park Light LENS Amber, 'Guide', Ea.	7.50 C
<u>17-104A-1</u>	LED Park Clear lens, amber lite Each	38.00 CF
<u>17-121</u>	GASKET, Park Light Lens, cork, Ea.	1.75 R

17-189



17-190

Stock 55 Tail Light LENS 'Guide' R

<u>17-189</u>	'Guide', USA [Danchuk] Ea.	7.50
<u>17-189A</u>	'Guide' USA [Trim Parts] Ea.	9.80
<u>17-190</u>	INNER Lens, Ea.	6.50

<u>17-188D</u>	Taillight HOUSING 55, Ea. Danchuk	59.00
<u>17-188GS</u>	Taillight HOUSING 55, Ea. Golden Star	49.00
<u>17-122</u>	Lens GASKET 55 Tail & Back-up, Ea.	2.50
<u>17-121S</u>	Lens GASKET SET 55 Park/Tail-Backup 4 pc	11.00



17-188

Tail Lens SEPARATION BAND Pr.	
<u>17-166</u>	Stainless, 11.00 RF
<u>17-166D</u>	Stainless, [Danchuk] 17.95 R



17-135
17-135A



55 Blue Dot Tail Light LENS	
<u>17-135</u>	Ea. 11.00
<u>17-135A</u>	Blue dot in line with bulb, Pr. 35.00



17-189B-1

17-189B-1 LED Tail Lens 55 RED Plug-in socket type Each 60 LEDs **39.00 CF**

21-437A L.E.D. FLASHER, Necessary if more than 2 LED lenses used **14.00 C**

New!

Full Size LED Tail Lens 55 RED Plug-in socket	
<u>17-189B-2</u>	Back Up Lens delete FULL SIZE stock look Each 66.00 CF
<u>17-189B-2S</u>	Back Up Lens delete FULL SIZE stock look Sequential Turn signal Each 85.00 CF



17-191

17-191 55 CUSTOM TAIL LENS, Covers tail & back-up lens area, Fills entire area within bezel. Smooth exterior, reflectorized inside surface. Pr. **49.75 C**



17-110

<u>17-110</u>	55 BACK-UP LENS Clear, 'Guide', Ea.	7.50 R
<u>17-110B</u>	55 BACK-UP LENS Custom RED not clear, to convert to an extra tail or tail & brake light. Pr.	21.50 C
<u>17-110C-1</u>	55 LED BACK-UP LENS CLEAR [26 LED's] Plug-in Each	49.00 C

20-146 Taillight MOUNTING KIT 55, for 1 car, screws, 'j' nuts to assemble to car & bezel **9.50 R**

17-115



17-126

17-115 LICENSE LIGHT LENS, Clear, 55-6 Pr. **6.50 R**

17-126 GASKET, License Light Lens, rubber, Pr. **10.50 R**

17-113A

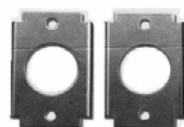

17-113A Back-Up Lamp CONVERSION PLATES 55-6, Pr. Screw to T/L housings for lamp sockets to plug into **19.90 R**

20-005 Back-Up LENS CLIP, 55, holds lens in at bottom, Ea. **2.50 R**

20-147 Taillight MOUNTING KIT, #20-146 with housing to body rubber seals **16.70 R**

56

17-106



17-106 PARK LIGHT LENS Clear, 'Guide', Ea
17-107 PARK LIGHT LENS Amber, 'Guide', Ea.
Each **7.50 C**



17-106A-1

56 PARK LIGHT LENS 35 LED
Each **35.00 CF**
17-106A-1 Clear lens, amber lite
17-107A-1 Amber lens, & lite



17-186

TAIL LIGHT LENS Each
17-136 with Blue dot Ea. **9.50 C**
17-186 'Guide', Ea. **7.50 R**
17-186A-1 LED Red 40 LED's No Plug, Splice in.
28.00 CF

17-112



17-112 56 BACK-UP LENS Clear
'Guide', Ea. **7.50 R**
17-112B 56 BACK-UP LENS Custom RED
not clear, to convert to an extra tail
or tail & brake light. Pr. **22.00 C**



17-192

17-192 CUSTOM TAIL LENS, 56
Covers entire tail light housing area within bezel.
Smooth dark exterior reflectorized inside surface.
Note: gas filler must be relocated,
Pr. **54.75 C**

- 17-112TP 56 BACK-UP LENS Clear 'Guide', Ea. Trim Parts **9.50 R**
- 17-112A-1 56 LED BACK-UP LENS CLEAR [26] Plug-in Each **45.00 CF**
- 17-115 LICENSE LIGHT LENS Clear, 55-6 Pr. **6.50 R**
- 17-123 GASKET, Park Lens, cork, Ea. **2.00 R**
- 17-124 GASKET, Tail Lens, cork, Ea. **2.00 R**
- 17-125 GASKET, Back-up Lens, cork, Ea. **2.00 R**
- 17-126 GASKET, License Light Lens, rubber, Pr. **10.50 R**
- 17-123S Lens GASKET SET, 56 Park/Tail/Backup 6 pc **11.00 R**



17-133

Tail Light REFLECTOR
17-133 Ea. [Trim Parts] **18.00 R**
17-133A Pr. import **8.00 RF**
17-133D Pr. [Danchuk] **29.90 R**

21-437A L.E.D. FLASHER, Necessary if more than 2 LED
lenses used **14.00 C**

57

17-108



PARK LIGHT LENS
17-108 Clear, 'Guide', Ea. **7.50 R**
17-109 Amber, 'Guide', Ea. **7.50 C**

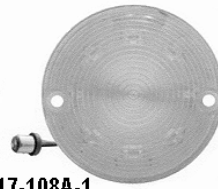

17-108A-1

17-108A-1 57 LED PARK LIGHT
LENS Clear lens, amber lite 9 LED
Each **28.00 CF**

21-437A L.E.D. FLASHER, Necessary
if more than 2 LED lenses used **14.00**



17-117

17-117 LICENSE LIGHT LENS,
57 except wagons w/gasket **15.00 R**
17-117 Import version **8.50 R**



17-132

17-132 57 TAIL LIGHT LENS 'Guide',
Ea. **7.50 R**



17-193

17-193 57 TAIL LIGHT LENS with
blue dot Ea. **11.00 C**



17-132A-1

17-132A-1
57 LED TAIL LIGHT LENS RED
[39 LED's] Plug-in socket type.
Each **35.00 CF**



17-114

17-132A-1S
57 LED TAIL LIGHT LENS RED
Sequential Plug-in socket type.
Switch for L or R Each **49.00 C**

17-114 57 BACK-UP LENS Clear
Glass, Ea. **12.30 R**

- 17-127 GASKET, 57 Park Light Lens, cork, Ea. **2.00 R**
- 17-128 GASKET, 57 Tail Lens, cork, Ea. **2.00 R**
- 17-129 GASKET, 57 Back-up lens, cork, Ea. **2.50 R**
- 17-127S Lens Gasket SET, 57 Park/Tail/Backup 6 pc **11.50 R**



12-141A

12-141A 57 BACK UP LAMP ASSEMBLIES, Complete; housings,
retainers, lens, gaskets, harness, Pr. (Danchuk) **179.00 R**
12-141A 57 BACK UP LAMP ASSEMBLIES import version **142.95 RF**



12-201A

12-201A Back Up Lamp BLOCK OFF
PLATE w/original retaining bracket, 1plate
& 1 bracket for 1 side, 57 **35.00 R**

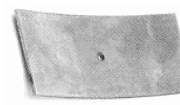

20-257

20-257 Back Up Lamp HOLE COVER
BRACKETS, 57 Pr. **12.95 RP**

License Light Assembly & Miscellaneous

License Light Assembly

Lens, Gaskets, Bulbs, Sockets, Wire, Housing Pr.
55 all, 56 & 57 Wagons



- 17-222 Fargo \$35.00 RF
- 17-222D Danchuk 49.90 R
- 17-222GS Golden Star 45.90 RF
- 56 except wagon Pr.
- 17-223 Fargo \$35.00 R
- 17-222D Danchuk 49.90 R
- 17-222GS Golden Star 45.90 RF



12-142

12-142 License Light BEZELS, Wagons chrome, Pr. 38.00 R

12-142A License Light BEZELS, with shoulder screws Wagons chrome, Pr. 33.00 RF

17-115



17-115 License Light LENS, clear, all 55-6 & 57 wagons Pr.. 6.50

17-126 GASKET license light lens all 55-6 & 57 wagons rubber Pr. 10.50



30-202D

Custom License Frame

30-202D Chrome w/3rd Brake & Tag Lights 45.00

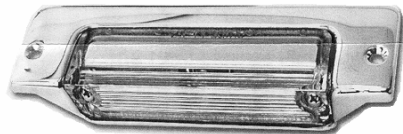

12-200A

57 License Light Assembly

- 12-200 57All except wagons 29.95 RF
- 12-200A 57All except wagons best quality [Danchuk] 69.00 R



20-442

20-442 License Light SCREWS, 57, 2 screws & 2 'j' nuts to install tag light in bumper 1.50



17-225A

17-225A LED {White} License Plate Fastener, Pr 11.00 C

LENS SCREWS

- 20-225 Zinc Plated, Set of 10 55-7 2.20 R
- 20-225S Stainless Steel, Set of 10 55-7 4.40 R

BOWTIE LENSES \$36.00 Pr except as noted

One Color

- | | |
|-----------------------------------|-----------------------------------|
| <u>17-A1026</u> 55 Park Amber, Pr | <u>17-A1027</u> 55 Park Clear, Pr |
| <u>17-A1386</u> 56 Park Amber, Pr | <u>17-A1387</u> 56 Park Clear, Pr |
| <u>17-A1484</u> 57 Park Amber, Pr | <u>17-A1485</u> 57 Park Clear, Pr |

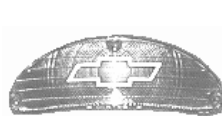

17-A1027C

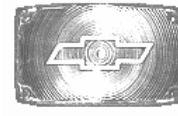

17-A1387C

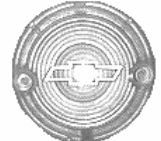

17-A1485C

With Chrome Outline 'Bowtie'

- | | |
|------------------------------------|------------------------------------|
| <u>17-A1026C</u> 55 Park Amber Pr | <u>17-A1027C</u> 55 Park Clear Pr |
| <u>17-A1386C</u> 56 Park Amber Pr | <u>17-A1387C</u> 56 Park Clear, Pr |
| <u>17-A1484C</u> 57 Park Amber, Pr | <u>17-A1485C</u> 57 Park Clear, Pr |

One Color [Red]

- 17-A1019 55 Tail Pr
- 17-A1379 56 Tail Pr
- 17-A1479 57 Tail Pr

w/ Chrome Outline 'Bowtie'

- 17-A1019C 55 Tail Pr
- 17-A1379C 56 Tail Pr
- 17-A1479C 57 Tail Pr



17-A1020B

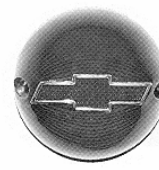

17-A1380B



17-A1480B

BLUE BOWTIE TAIL LENSES

Tail lens with Blue Bowtie and chrome border

- | | |
|-------------------------------|-------------------------------|
| <u>17-A1020B</u> 55 39.75/Pr. | <u>17-A1380B</u> 56 39.75/Pr. |
| <u>17-A1480B</u> 57 39.75/Pr. | |



17-317B

BOWTIE DOTS Pr. 22.00 C

- 17-317B BLUE 17-317R RED
- 17-317A AMBER

- 17-256 BLUE DOTS, w/chrome bezels, glass dots, Pr. 3.00 C

SMALL BULBS



17-120



17-184



17-187



17-209



17-261

- 17-184A DASH BULB SET, 55-6; cluster, clock, radio, heater 20.00 R
- 17-184B DASH BULB SET, 57; cluster, clock, radio, heater 20.00 R
- 17-120 BULB, single contact for back-up sockets, (1156) Ea. 1.35 R
- 17-184 BULB, dash light (53), Ea. (dash warning lights) 1.25 R
- 17-262 BULB, dash light (57), Ea. (brighter than 17-184) 1.25 R
- 17-261 BULB, double contact Large dome light, (1004) Ea. 1.50 R
- 17-261A BULB, double contact Small dome housing, all with 2 dome lamps 55 2 dr Ht and some nomads. (90) Ea. 1.50 R
- 17-187 BULB, park or taillight, (1157) Ea. 1.25 R
- 17-209 BULB, license light sockets, & 55-6 clock (67) Ea. 1.25 R
- 21-002W LED Ribbon Strip Lights 12" long can be trimmed to shorter length, w/black & red wire ends peel off sticky backing, 3/8 wide, 1/8 high. Used for backlighting gauges ETC.. White 19.00

Headlight Bulbs, Rings, Holders & Buckets

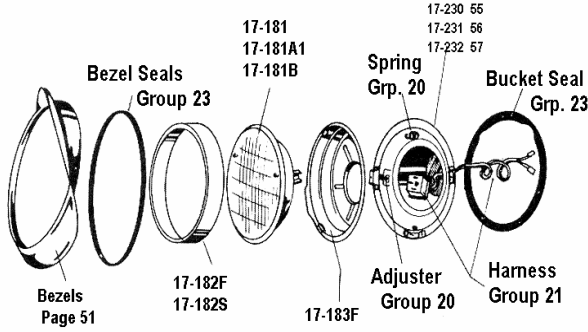

- 17-182F** Headlight BULB RETAINING RING 3 screw type made in USA, Ea. **13.50 R**
- 17-182S** Headlight BULB RETAINING RING type with slot for tab on bulb holder, Ea **13.50 RF**
- 17-183F** Headlight BULB HOLDER orig. style, bulb sits in this part, use with 17-182F Ea. **29.90 RF**
- 20-213** Headlight Bulb RETAINING RING SCREW, Also Distributor Point Screw, 53-62, Ea. **.30 R**
- 17-255** Headlight Bulb HALF-MOON COVERS, Pr. **12.00 C**

Headlight BULBS Sealed Beams

- 17-181** REPLACEMENT Sealed Beam, Ea. *N/A* Use 17-181B
- 17-181A1** 'T-3', Repro original 56-7 Sealed Beam, Pr. *N/A*
- 17-181B** HALOGEN Sealed Beam, Ea. **17.50 Rp**
- 17-181BX** XENON Sealed Beam, Ea. **28.00 Rp**



Headlight Bucket Assembly

- 3 pc w/Bulb holder & Ring
- 17-230S** 55 Each **59.95 R**
 - 17-232S** 57 Each **74.95 R**

17-230S



17-230

Headlight Buckets includes bezel clips & adjusters seconds are available

- 17-230** 55 Ea. *N/A*
 - 17-231** 56 Ea. *N/A*
 - 17-232** 57 Ea. *N/A*
- CALL, We have some SECONDS

Interior Courtesy Light Lens & Bezels



17-270F

Small Dome Light Chrome Housing

- 53-55 HT/all Nomads, 2 required
- 17-270F** W/lens, no bulb. Sold Each **34.00**
 - 17-270FD** Danchuk version **37.00**

17-131

Small, 2 required, 55 HT, 55 & 57 Nomad,

- 17-131** Original circle pattern Each **4.90 R**



- 17-131A** Smooth replacement Each **3.85 RP**



17-165

Dome Lens Chrome BEZEL

For large single light

- 17-165** USA **13.00 R**
- 17-165-1** Danchuk **18.50 R**
- 17-165P** Foreign version **12.00 R**

17-164



Dome Light LENS

- 17-130** Large single light, replacement circle pattern **6.50 RP**
- 17-164** Large single light, Original smooth cream lens **6.75 R**

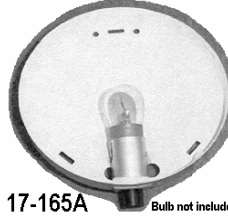

17-165A Bulb not included

Dome Light Housing

55-60 Large Single Type in middle of headliner

- 17-165A** **25.00**
- 17-165D** Danchuk version **34.00**
- 17-165F** Import **17.00**

Dome Light ASSEMBLY Large single

Includes housing, bezel, lens & bulb

- 17-165G** Assembly **32.00 RF**
 - 17-165LED** LED Assembly **62.00 CF**
 - 17-270A** Dome Light WIRE CONNECTOR to dome lite housings sedan or HT, snaps into original housing. Crimp style. Ea. **.85 RP**
- Dome Light Switches See Group 21B

Grp 17B

Radiator

UPPER Radiator Hose, Molded



- 17-137** 6 cyl, Upper 55-56 w/GM # **30.00 R**
- 17-280** 6 cyl, Upper 57 w/GM # **30.00 R**
- 17-139** V8, Upper, all exc. 2-4's and FI w/GM # **22.50 R**
- 17-139-1** V8, Upper, all exc. 2-4's and FI w/GM # w/clamps **30.00 R**
- 17-139A** V8, Upper 2-4's & Fuel Injection w/GM # **45.00 R**
- 17-139B** V8, Upper, custom for cars w/rad. mounted in front of support, can be trimmed to fit most applications **23.00 C**
- 17-139C** V8, Upper LS motors with Rad in front of Support, [hose id smaller id one end 1.25" x 1.50"] trim to fit **22.00 C**
- 17-139D** V8, Upper, LS motors to 17-GRIF19 radiator, [hose id 1.25" x 1.50"] trim to fit your needs **22.50 C**
- 17-139E** V8, Upper, Ram Jet 350 motor to 57 type 6 Cyl radiator [outlet offset to drivers side] **40.00 C**
- 17-139F** Upper Rad Hose Tuned port to Griffin X flow 1.5" both ends 20" long 3 bends **25.00 C**

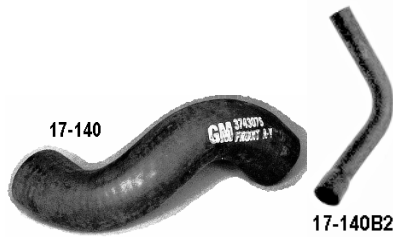

LOWER Radiator Hose, Molded

- 17-138 6 cyl, Lower 55-57 w/GM # **35.00 R**
- 17-140 V8, Lower w/GM # **22.50 R**
- 17-140-1 V8, Lower w/GM # w/clamps **30.00 R**
- 17-140B V8, Lower, custom for cars w/rad. mounted in front of support, can be trimmed to fit most applications **19.50 C**
- 17-140B1 V8, Big Block, Lower, all **35.00 C**
- 17-140B2 V8 motors w/1.5" outlet to 6 cyl position radiator, usually serpentine reverse rotation **22.00 C**
- 17-140D V8 LS motors to 17-GRIF19 Radiator **28.75 C**



HOSE CLAMPS Original Spring Clamps

- 17-141 Radiator & Heater Set/8 55-6 all, 57 Standard Heater **19.00 R**
- 17-142 Radiator only, Set of 4, all **11.00 R**
- 17-143 Radiator & Heater, Set of 10, 57 Deluxe Heater **24.00 R**
- 17-144 5/8" heater hose original style Spring Clamp, ea. **.95 R**
- 17-145 3/4" heater hose original style Spring Clamp, ea. **2.50 R**



9588

- All Stainless Hose Clamps Each
- 9585 .5-1.25, 5/8" Hose **3.00**
- 9586 .5-1.25, 3/4" Hose **3.50**
- 9588 1-2", 1-1/2" Upr Rad Hose **3.00**
- 9589 1-5/16 -2-1/4", 2" Lwr Rad **3.00**

THERMOSTAT



17-197

- 17-196 160 degree (AC) *Discontinued*
- 17-196-1 160 degree **7.90 RF**
- 17-197 180 degree, (AC) **15.00 R**
- 17-197-1 180 degree **4.50 RF**
- 17-197A 195 degree, (AC) **13.50 R**
- 17-195 GASKET, Thermostat Cover **2.50 R**

- 17-194A Thermostat Iron BASE, 6 Cyl, bolts to head S/O **48.00 R**



17-194A

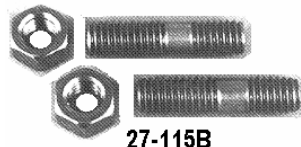

27-115B

- Thermostat Cover STUDS aluminum intakes
- 27-115A , steel Ea. **1.60 R**
- 27-115B stainless Pr. **9.80 R**



17-171A 17-148 17-148A

- 17-171A FILLER PANEL, V8 Radiator Support lower **19.90 R**
- 17-148 PETCOCK, for radiator drain as original **7.00 R**
- 17-148A DRAIN HOSE, for Radiator Petcock **4.00 R**
- 17-148RP PETCOCK Replacement has no tube for hose **6.50 RP**

- 17-149 DRAIN PLUG, Engine block, 2 required, Ea. **2.00 R**

THERMOSTAT COVERS



17-194

- 17-194 Thermostat COVER, all V8 exc 2 4's & FI **19.90 R**



30-068C

30-068C2

30-068A, B



30-068C

- Early SB Chrome
- 30-068A Angle Neck **16.00**
- 30-068B Angle Neck O-ring gasket **14.75**



30-068C

30-068C2



30-068E

- Polished Aluminum SWIVEL O-ring
- 30-068D 90° **29.00**
- 30-068E 45° **22.00**



30-068E1



30-068F

- O-ring SWIVEL
- 30-068E1 45° chrome aluminum **35.00**
- 30-068F 15° polished aluminum **29.00**



30-068G

30-068H

30-068J

30-068K



30-068H



30-068J



30-068K

- 30-068G HARD LEFT Angle O-ring gasket chrome **13.50**
- 30-068H SOFT LEFT Angle O-ring gasket chrome **14.00**
- 30-068J LEFT Angle pipe thread boss O-ring Chrome **25.00**
- 30-068K LS engines Swivel, Chrome, Ea. **39.00**



17-146-1



17-146F1

RADIATOR CAPS

- 17-146-1 7 lb. Stock **6.00 RP**
- 17-300 7 lb. Stock Exact Original w/original markings **29.95 R**
- 17-146-2 9 lb. **6.00 RP**
- 17-146-3 10 lb. **7.00 RP**
- 17-146A 13 lb. use with US Radiator repro radiator **16.00 C**
- 17-146D 13 lb. use with US Radiator & Overflow tank **12.00 C**
- 17-146E 16 lb. use with Griffin Rad & Overflow tank **12.00 C**
- 17-146F1 16 lb. Brushed Aluminum octagon shape no logo **30.00 C**
- 17-GRIF20D 16 lb. Griffin Radiator Cap Steel **25.00 C**

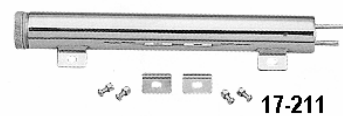

17-211

RADIATOR OVERFLOW TANKS

- Polished Stainless w/mounting brackets & hardware,
- 17-211 13" long 1 1/2" dia. **\$53.00**
- 17-211B 15" long 1 1/2" dia. **\$59.90**

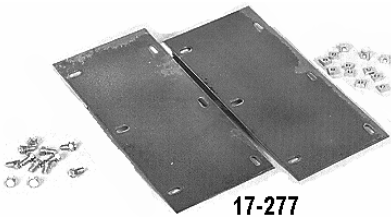

17-277

17-277
Radiator
RELOCATION
PLATES, move stock
V8 radiator to front
of stock V8 support
for more fan & access
room. **62.00 C**



17-171

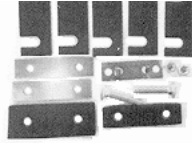

17-171-S

- 17-171** Rad Support CENTER MOUNT bolts, metal plates **15.00 R**
17-171-S Rad Support MOUNT Kit with 17-171 & 23-173 **18.90 RF**
17-171-S2 Rad Support MOUNT Kit with 17-171 & 23-173 **20.00 R**

Radiator Support SHIM SETS

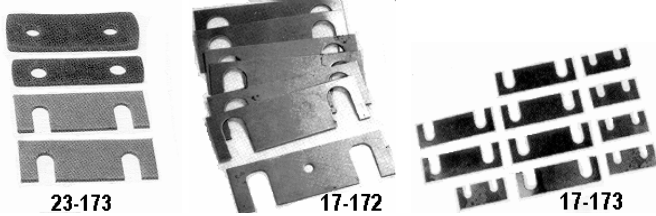

23-173

17-172

17-173

- 23-173** SHIM KIT, at CENTER all, fiber & rubber shims **15.00 R**
17-172 SHIM KIT, at SIDES, to fenders **9.95 R**
17-173 SHIM KIT, at sides & 57 Grill Tie Bar to fender **13.00 R**
17-173A SHIM KIT, 57 Grill Tie Bar only **6.00 R**

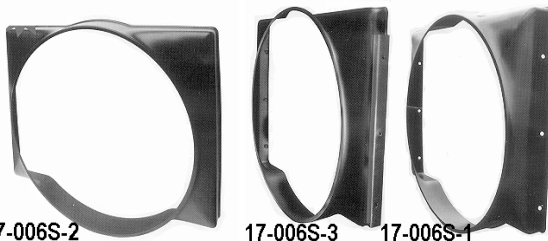

17-006S-2

17-006S-3

17-006S-1

STEEL FAN SHROUD

Important Notes: Fan opening in either is 18.25". With V8 shroud & Power Steering use Fan #28-127C or #27-127E2

- 17-006S-1** 6 Cyl Rad Support, Radiator in front of support **150.00 R**
17-006S-1A 6 Cyl Rad Support, Chrome w/Black Brackets **289.00 R**
17-006S-1B 6 Cyl Rad Support, Chrome mount Brackets only **79.00 R**
17-006S-2 V8 Rad Support, Radiator behind support **150.00 R**
17-006S-2A V8 Rad Support, Chrome w/Black Brackets **289.00 R**
17-006S-1B V8 Rad Support, Chrome mount Brackets only **79.00 R**
17-006S-3 V8 Rad Support, V8 Radiator installed w/17-277 brackets to the front of support **159.00 R**



17-005

17-005
INSECT SCREEN, 56-7 original
Radiator Accessory
N/A

Radiator Notes ! Petcocks 17-148 or 17-148RP are not included, order separately. Original V8 radiators mounted on engine side of radiator support, original 6 cyl. cars mounted radiator on grill side of support. Check your radiator support mounting before ordering. If the radiator mount brackets are on the engine side of the support you have a V8 support, if the mount brackets stick out in front of the support you have a 6 cyl. support. The cooling capacity is the same on 6 or V8 radiators. In fact if you are building a modified car it is better to mount the radiator in front of the support. You will have more clearance for pulleys and accessibility plus you can mount the mechanical &/or electric fan of your choice. All radiators no name or numbers stamped into the top tank. Note; V8 position radiators wider bottom tank this requires the filler panel in bottom of V8 support, to be removed. *Oversize shipping. Big block installations use 17-278, 278A. Use 13 lb cap .



17-244

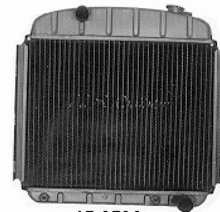

17-278A

US Radiator
made in USA
Copper/Brass
(No Tank Numbers)

- 17-243** V8 Mnt 55-7 4R Stick 'Desert Cooler' **750.16**
17-244 V8 Mnt 55-7 4R Trans Cooler 'Desert Cooler' **784.77**
17-274 V8 Mnt 55-7 All 3R Std Core Trans Cooler **710.55**
17-274 V8 Mnt 55-7 All 3R Std Core Trans Cooler **710.55**
17-275 V8 Mnt 55-7 Stick 3R Std Core **675.94**
17-271 '6' Mnt 55-6 3R Std Core Trans Cooler **728.93**
17-272 '6' Mnt 55-6 Stick 3R Std Core **719.20**
17-273 '6' Mnt 55-6 All 3R HE Core Trans Cooler **763.54**
17-278 '6' Mnt 55-6 All 4R Trans Cooler **828.03**
17-278HE '6' Mnt 55-6 3R H/E Core Trans Cooler **919.98**
17-279 '6' Mnt 55-6 4R Stick 'Desert Cooler' **793.42**
17-271A '6' Mnt 57 All 3R Std Core Trans Cooler **730.01**
17-272A '6' Mnt 57 Stick 3R Std Core **686.75**
17-273A '6' Mnt 57 All. 3R HE Core Trans Cooler **838.43**
17-278A '6' Mnt 57 All 4R Trans cooler Left inlet **784.77**
17-279A '6' Mnt 57 Stick 4Row 'Desert Cooler' **851.68**

Aluminum Radiators from US Radiator

All fit stick or automatic. 2 row 1" tubes. Petcocks 17-148 or 17-148RP are not included order separately

- 17-AL10040** V8 mount **562.50**
17-AL100408 6-cyl-mount 55-56 center upper hose nipple requires mods to 57 hood brace to clear hose **562.50**
17-AL10057 6 Cyl mount 57 left upper hose nipple **562.50**
17-AL10056 Crossflow **562.50**
17-AL100561 Crossflow w/1620 cfm dual Spal fans & shroud **937.50**



17-AL100408

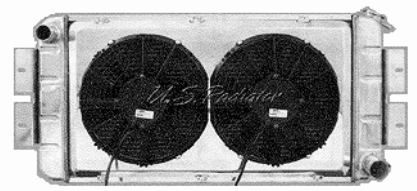

17-AL100561

Cold Case Aluminum Radiator

Made in the **USA** Stock appearance, paint it black & it will look as original
2 row 1.25" tubes w trans cooler.

Note: If modified engine with updated accessories & steering, radiator should be mounted on grill side of support

- 17-CCCHT562A** Mounts on engine side of support, [stock V8 position] 55-7 **399.**
- 17-CCCHT563A** Mounts on grill side of support. [stock 6 cyl position] **399.**
- 17-CCCHT563A-7** Mounts on grill side of support. Has 57 upper hose offset to left to match hood brace cut out. [stock 6 cyl position] **399.**

Aluminum Import Radiators by Auto City

- 17-SL264AT** V8 mount Auto **229.00**
- 17- SL264AT** V8 mount Auto w/Fan & Shroud **368.00**
- 17- SL264ATPL** V8 mount Auto Polished **259.00**
- 17-SL265AT** 6 Cyl mount Auto center upper hose nipple **229.00**
- 17- SL265AT** 6 Cyl mount Auto w/Fan & Shroud **368.00**
- 17- SL265ATPL** 6 Cyl mount Auto Polished **259.00**

NOTE 6cyl mount are center upper hose nipple 57's will require cutting out the hood brace to clear

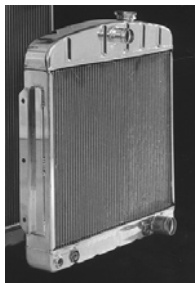

Griffin'®Aluminum Downflow Radiators

2 row 1-1/4 tubes, equal to 4 row copper/brass radiator, downflow, Made in USA. Stick & Auto trans. Fits stock radiator support, V8 refers to stock rad mounting behind support, '6' refers to rad mounting in front of support. Petcocks included in kits only. Use 15 or 16# cap

- 17-GRIF7** V8 position; engine side of rad support **\$925.00**
- 17-GRIF9** '6' position; grill side of support 55-6 top spout center of tank **\$925.00**
- 17-GRIF11** '6' position; grill side of support 57 top spout driver's side of tank Stick versions of above available [no cooler] **\$895.00**

Griffin Downflow Direct Fit Radiator Kits

- 17-GRIF7-KIT** Griffin Down flow Combo Unit Direct Fit V8 position w/fan, shroud, wiring & sensor, cap. 1.50 TC, 1.75 BR outlet. Aluminum 1-1/4 tubes 2 rows. Trans cooler **1399.00**
- 17-GRIF9-KIT** Griffin Down flow Combo Unit Direct Fit 55-6 '6' position w/fan, shroud, wiring & sensor, cap. 1.50 TC, 1.75 BR outlet. Aluminum 1-1/4 tubes 2 rows. Trans cooler **1399.00**

GRIFIN Radiators **Polished. Add \$225.00**
Call for Griffin Radiator Caps several styles available



17-GRIF-01

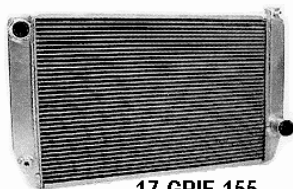

17-GRIF-155

Economical Universal Fit Dominator Series

- 17-GRIF-01** Down flow Combo Unit fits 6 or V8 position w/fan, shroud, wiring & sensor, cap. Outlets 1.50 TC, 1.75 BR Aluminum 1-1/4 tubes 2 rows, trans cooler. Dominator series. **825.00**
- 17-GRIF-01A** Down flow Radiator fits 6 or V8 position, w/shroud for most 16" fans. 1.50 TC, 1.75 BR outlets. 1-1/4 tubes 2 rows. Core 22 H, 17 W. Trans cooler. **525.00**
- 17-GRIF-155** Universal Fit Performance RADIATOR, No mount brackets 2 row 1.25 tubes. Overall Size 31w x 15.5h x 3" thick Crossflow manual [no trans cooler] Top L 1.5" inlet, Bottom R 1.75" outlet. **350.00***

Griffin'®Aluminum Crossflow Radiators

Petcocks & Radiator Caps are included in kits only, not included on individual radiators

17-GRIF19 Griffin Crossflow 3 Tank Direct Fit Radiator Kit Mounts in front of rad support. Assembly mounts directly to V8 rad support and uses stock V8 lower rad hose as it has an extended tube from **unique 3rd tank on bottom**. Auto trans lines go in bottom tank like stock. Upper hose goes thru left side filler panel, AC hoses go thru right side Comes with dual fans, AC Condenser & Griffin rad cap. Well thought out and designed. Eliminates complications found on other brands. **1990.00**

17-GRIF19A Griffin Cross flow Radiator only. 3 tank Standard configuration. Aluminum 2 rows 1-1/4 tubes. Trans cooler Outlets 1.50 Upr L/ 1.75 Lwr R **950.00**

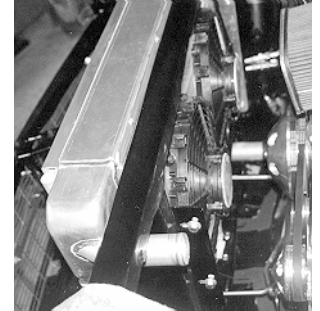

Polishing available at additional \$275.00.



Griffin Crossflow Direct Fit Radiator Kits for LS
3 tank, Fits 55-7 V8 radiator supports

- 17-GRIF19-1LS** Griffin Cross flow Combo Unit. LS1, 2 and early 3. w/condenser, fan, shroud, wiring & sensor, cap. Aluminum 2 rows 1-1/4 tubes. Outlets 1.25 Upr R/ 1.50 Lwr R. Trans cooler **1990.00**
- 17-GRIF19-3LS** Griffin Cross flow Combo Unit. LS3. w/condenser, fan, shroud, wiring & sensor, cap. Aluminum 1-1/4 tubes 2 rows. Outlets 1.25 Upr L/ 1.50 Lwr R. Trans cooler **1990.00**
- 17-GRIF19A-LS** Griffin Cross flow Radiator only. LS1, 2 and early 3. Aluminum 2 rows 1-1/4 tubes. Outlets 1.25 Upr R/ 1.50 Lwr R. Trans cooler **950.00**
- 17-GRIF19A-LS3** Griffin Cross flow Radiator only. LS3. Aluminum 2 rows 1-1/4 tubes. Outlets 1.25 Upr L/ 1.50 Lwr R. Trans cooler **950.00**
- 17-011** Griffin Crossflow RADIATOR TOP CORE COVER laser cut 'Chevrolet' script, 24" long 3-3/8 wide, 3-1/4 wide inside **79.00**

Electric RADIATOR FANS

NOTE: See Group 28 for regular Fan Blades.

TECH Note: If using an electric as your only fan install behind radiator.
Call for others.



17-008E

- 17-008E** 16" reversible Heavy Duty can be used without engine fan 2200 cfm mounts in front or behind radiator 4" deep **155.00**
- 17-008E2** 16" reversible Heavy Duty can be used without engine fan 2100 cfm mounts, curved blades 4" deep **195.00**

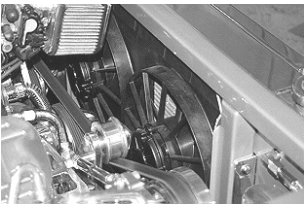

17-008F DUAL FAN KIT for 6 cyl rad support only fits inside support includes wiring kit and mounting, requires trinary switch with AC [Vintage Air] includes #V-32111-SDF fans **435.00**

V-32111-SDF DUAL ELECTRIC FANS fits inside rad support, puller. Use behind radiator 2 11" fans 2780 cfm. Not a bolt-in requires mount work. **358.00**



17-009H1 ELECTRIC FAN SWITCH, on 195°, off 180°, 3/8 NPT [3/8-18] can be used with 17-009G **75.00**

17-009E ADJUSTABLE Electric FAN SWITCH 180-240° has probe to insert in radiator fins. (Vintage Air) **42.00**

17-009F Wiring Kit for #17-009E, includes 30 amp relay & 40 amp circuit breaker (Vintage Air) **55.00**

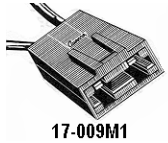

17-009M1

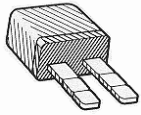

17-009M2

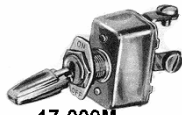

17-009M

17-009M1 Fuse HOLDER for ATO/ATC fuse, 12g wire 3-30 amp Ea. **3.00**

17-009M2 CIRCUIT BREAKER 30 amp auto re-set has break-off legs to fit fuse holders or panels [for regular fuses see Group 21 page 130, 131] **8.75**

17-009M TOGGLE SWITCH 35 Amp HD use with electric fans when you desire to control fan directly be sure to fuse fan according to fan requirements, see also 17-009M1 & 12537-42. Ea. **9.75**



17-009B-1

17-009B1 ELECTRONIC THERMOSTAT for Electric Fan, has adjustable programmable range [Dakota Digital] **119.95**



17-009G

17-009G Universal RELAY KIT, can be used manually or in conjunction with a temp. sending switch. Designed to be used with a fused power source (not included). 30 amp relay. Instructions for both switched & manual operation included. Can be used in most situations where a relay is required **26.00**

Grp 17

Steering Column



17-079A



17-079



17-086

Column SHIFT COLLAR 55-6

17-079A Stock with shift lever bulge **39.90 R**

17-079AU Stock with shift lever bulge, good used **29.00 R**

17-079 Modified without shift lever boss [floor shift] **39.80 C**

17-086 WIRE SPRING, 55-6 on automatic shift tube in column gear indicator wire attaches to this, ea **9.00 R**



17-087

Column **Shift Detent BRACKET** Bottom of column

17-087 Original Powerglides **21.00 R**

17-087T Turbo 350/400/700/200 **20.50 C**



17-167

Steering Column BEARING with horn wire & contact band ASSEMBLY R

17-167 Danchuk **27.00**

17-167A Cal. Cl. Chevy] **23.00**

17-175

Column COIL SPRING, goes under wheel **3.00**



17-168

17-168 LOWER Steering Column BEARING, a real bearing that bolts into stock columns providing needed support when using rack & pinion steering or as required by other mods. **N/A**

17-283



17-282

17-282 Steering Column THRUST WASHER, fits into shift lever housing under turn signal housing **4.40 R**

17-283

Steering Column TANGED WASHER, fits into mast jacket under shift lever housing, 55-6 **4.40 R**



17-099A

17-099A Turn Signal WIRE HARNESS SHIELD, on column, 55-6 **12.00 RF**

17-285

Steering Column FELT WASHER, Middle Inner **8.00 R**



17-176

17-176 Turn Signal Housing Lock Plate, to Steering Column. holds signal housing to slots in top of steering column **8.00 R**

17-286 SCREW, Turn Signal Housing Lock plate, set of 3 w/attached stars **5.00 R**



17-288

17-288 Steering Column Lower SPRING ASSEMBLY, between column & spring, shouldered washer and felt washer **14.50 R**



17-295

17-295 Steering Column Overhaul Kit includes 17-282, 283, 285, 286, 288 & 17-176) all small parts from inner column below turn signal housing to steering box **29.00 R**