



- 17-088** SLEEVE 57 steering column upr. mount, ea.(2 required) **2.00 R**
- 17-088A** 57 STEERING COLUMN MOUNT KIT includes rubber grommets, sleeves , bolts, washers. **12.00R**
- 17-099B** Lower Steering Column Cover BRACKET, 57 **14.75 R**



- 17-099C** UPPER Steering Column BRACKET, 55-6 fits between column & dash support [available good used also] **19.95 R**
- 17-099D** LOWER Steering Column BRACKET, 55-6 holds column & bottom cover in place [also available used] **28.95 R**
- 17-099E** LOWER Steering Column BRACKET, 57 [call for used] **29.95 R**



STEERING COLUMN FASTENER KIT
 All fasteners to assemble column & install in car, including wheel, horn ring & center cap

- 17-295A** 55-6, B/A,210 56 pc **29.00**
- 17-295B** 57, B/A,210 70 pc **30.00**

- 17-087A** Screw, SHIFT DETENT BRACKET to steering column, auto trans. #12-24 indented hex head w/star washer, Pr. **3.50 R**
- 
- 17-087B** Screw, 57 Column Support BRACKET TO COLUMN, indented hex washer head as original, Pr. **3.50 R**
 - 17-087C** Screw, 57 Shift Housing Support BRACKET TO COLUMN Phillips pan head w/star washer as orig., 1 req. Ea. **2.00 R**
 - 17-087E** Screw, Outer COLUMN TO Bottom BUSHING auto columns 5/16-24 short ind. hex head w/star as orig., set/3 **7.00 R**
 - 17-087D** Screw, Outer COLUMN TO Bottom BUSHING stick columns 1/4-28 short ind. hex head w/star as original, Set/3 **3.50 R**

- 17-177** Steering Wheel RETAINING NUT **1.20 R**
- 17-177A** WASHER for Steering Wheel Retaining Nut, correct small diameter **.80 R**
- 17-177C** SCREW Turn Signal Lever to Housing w/lock washer **1.50 R**

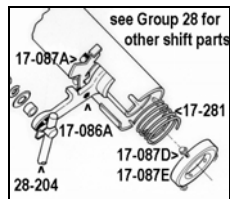

17-281 SPRING, Lower Steering Column between shift lever and bottom bushing, auto columns, ea. **8.50 R**



HORN RING REPAIR KITS
 For horn ring, made correctly in USA; w/instructions.

- 17-200** **55-56**, [17-150, 151, 153, 154, 170 & 3/179] **27.00 R**
- 17-200NS** **55-56**, minus horn spring [17-150,151,153, 170,3/179] **19.00 R**
- 17-200D** **55-56**, Danchuk version **29.00 R**
- 17-201** **57**, 17-150, 152, 154, 169, 170 & 3 of 179 **27.00 R**
- 17-200NS** **57**, minus horn spring [17-152,169,170, 3/179] **19.00 R**
- 17-201** **57** Danchuk version **29.00 R**

- 17-170** Horn Contact INSULATOR, for 17-150 **5.50 R**
- 17-150** Horn CONTACT, correct original, goes thru steering wheel w/correct bearing bronze contact **10.00 R**

HORN Individual PARTS

- 
- 17-151** RETAINER, 55-6, insulates mounting screws from ring & spaces horn ring correctly **5.00 R**
 - 17-152** RETAINER, 57, insulates mounting screws & spaces horn ring correctly **5.00 R**
 - 17-153** PLASTIC SPACER, 55-6, goes under ring **4.00 R**
 - 17-169** PLASTIC SPACER, 57, goes under ring **4.00 R**
 - 17-154** SPRING, all Bel Air's & 210's (goes under ring) **8.00 R**
 - 17-179** Horn Ring RETAINER SCREW, orig. washer head, ea. **1.00 R**
 - 17-179A** Horn Ring CENTER CAP SCREWS, 55-6 B/A **2.00 R**
 - 17-179B** Horn Ring CENTER CAP SCREWS, 57 B/A & '210' **2.00 R**

- 
- 17-296A** HORN, replacement, High Note, Ea. **30.00 RP**
 - 17-297A** HORN, replacement, Low Note, Ea. **30.00 RP**
 - 17-299** Restored STOCK HORNS Pr Exchange Only, Specify Year Send yours first, don't send junk. **200.00 RU**
 - 17-298A** 55-6 Horn COVER For original horn, Ea. **21.00 R**
 - 17-298AC** 55-6 Horn COVER Chromed for original horn, Ea **29.00 C**

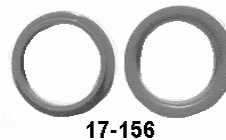
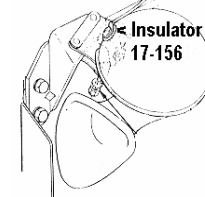

17-156 Horn Wire Connection RED Insulators one on each horn, 55-6 Pr. **7.95 R**

Turn Signal Switch

- 21-20015** 55, w/correct terminals **22.75 R**
- 21-20016** 56, w/correct terminals & connector **22.75 R**
- 21-20017** 57, w/ correct terminals & connector **22.75 R**

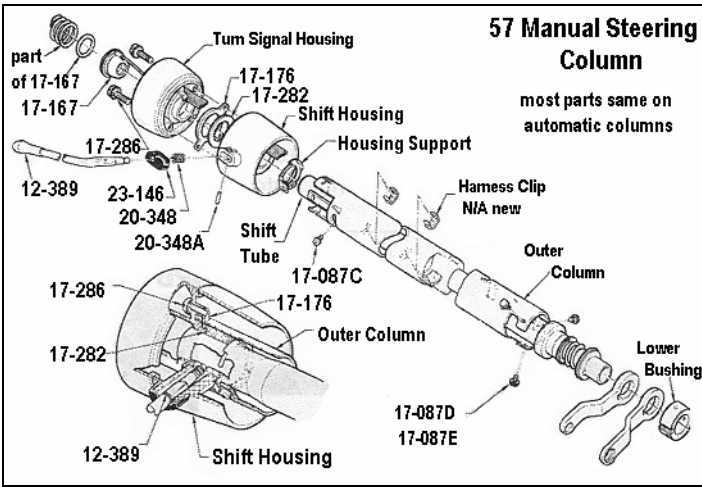

57 Manual Steering Column

most parts same on automatic columns

CRC-1000-3 LS Drive by Wire Cruise Control w/Turn Signal Handle Control for aftermarket columns (Dakota Digital) **395.00**

Tilt Steering Columns

All new parts. Columns as listed below are for column only. Levers for application are included. Column Shift include neutral switch. All other items are separate. Rag-joint not included, must be chosen according to steering box used. Items necessary to complete installation are listed separately on next page Use of stock wheel requires additional mods, see #17-150B next page.



FR20023-55SS

Column TURN SIGNAL Parts



- 21-008 Turn Signal Canceling EARS, Pair **3.00 R**
- 21-008B Turn Signal Canceling EARS & SPRINGS, 4 pc Set [21-008 & 21-203] **9.95 R**
- 21-008A Signal Mechanism BUSHING & 2 Ear CUSHIONS **3.50 R**
- 21-008A-1 Turn Signal Mechanism Canceling Ear CUSHION [part of 28-008A kit] Each **1.00 R**
- 21-008A-2 Turn Signal Mechanism Canceling Ear BUSHING [part of 28-008A kit] Each **1.50 R**



- Turn Signal Canceling Cam Screws to bottom of steering wheel
- 21-238 55-56 **5.95 R** 21-238D 55-56 Danchuk **12.75 R**
 - 21-239 57 **5.95 R** 21-239D 57 Danchuk **12.75 R**

- 21-419 Turn Signal MECHANISM, die cast part the chrome lever screws to **10.90 R**

Shortened Automatic Stock Steering Column



Column shift for 605, Concept One, 10-351 or 10-287G & G1 steering boxes. Includes; steering shaft, inner shift & outer tube, lower clamp & firewall trim plate. Does not include rag-joint or turn signal & shift lever housing. Choose rag joint according to your steering box[use #10-B055049 rag joint to connect to #10-351]. Re-use your stock upper housings. All new parts no exchange necessary **\$269.00**

- B-990042 55-6 Shortened Steering Column 27.88 overall long
- B-990043 57 Shortened Steering Column 29.13 overall long

- SC990 55-56 Floor Shift Paintable Mill Finish **425.00**
- SC991 55-56 Floor Shift Chrome **475.00**
- SC992 55-56 Column Shift Paintable Mill Finish **475.00**
- SC993 55-56 Column Shift Chrome **509.00**
- FR2023-55SS 55-56 Column Shift Polished Stainless **N/A**

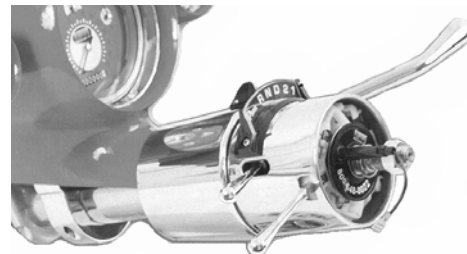

FR20023-57-CU

57s have the shortest hub & dash cluster shroud you can find at 6-3/8", stock is 4-3/8" Choosing a Flat steering wheel can make up most of this. Stock steering wheel is 4-3/4 deep.

- SC994 57 Floor Shift Paintable Mill Finish **425.00**
- SC995 57 Floor Shift Chrome **465.00**
- FR20005-57SS 57 Floor Shift Polished Stainless **997.00**
- SC996 57 Column Shift Paintable Mill Finish **475.00**
- SC997 57 Column Shift Chrome **509.00**
- FR20023-57-CU 57 Column Shift Paintable Mill Finish with Trans indicator on column spec Kit # below **N/A**



Column Shift Indicators

Plain Acrylic is 2-side tape stick on no bezel fits IDIDIT 4" diameter column **Call for others**

- ID-26000010 3 spd **35.00** ID-26050010 4 spd OD **35.00**



RAG-JOINTS
See Group 10 Page 15
Steering section for full selection

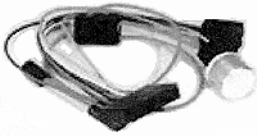

Turn Signal & 4-way Hazard Harness
Kit for Flaming River columns
\$39.00
21-467B 55 21-468B 56
21-469B 57

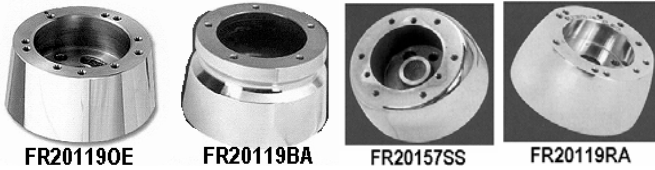

Flaming River Steering Wheel Adapter Hubs
FR201190E Tapered for 5/6 bolt wheel 2.5" tall **135.00**
FR20119BA Bell for 5/6 bolt wheel 2.5" tall **139.00**
FR20157SS Rounded top edge 5/6 bolt pattern 1-13/16" tall **199.00**
FR20119RA Tapered 5/6 bolt wheel pattern 1-7/8" tall **146.00**

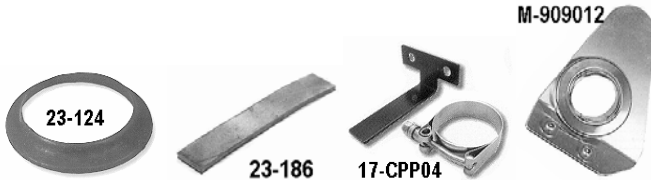

23-124 Column GROMMET, 55-56 trims Gauge Cluster **6.00 R**
23-124D Column GROMMET, 55-56 trims Gauge Cluster Danchuk **7.00 R**
23-186 Column Mount Pad around column to Dash Support **7.00 R**
17-CPP04 COLUMN FLOOR MOUNT secure lower part of your custom column to existing holes in toe board. 55-7 **23.00**
M-909012 COLUMN FLOOR MOUNT RING polished replaces stock Firewall clamp, mounts inside car, for 2" columns **97.00**

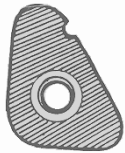

Column Sponge Seal R

23-116 Stick trans. Rt66 **16.00**
23-116D Stick trans Danchuk **19.90**

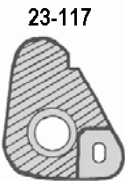

23-117 Auto. trans. Rt66 **16.00**
23-117D Auto. trans. Danchuk **19.90**



Column Ribbed Cover \$19.50 R

23-118 23-119 23-120

23-118 Stick trans. 55-6 23-119 Auto trans. 55-6
23-120 Stick trans. 57 23-121 Auto trans. 57

15-144 Clutch Pedal Push Rod FELT GROMMET Firewall **8.00 R**



Stock Steering Wheel to Tilt Column HORN KITS

17-150D TURN SIGNAL CANCELING CAM w/Horn Contact Plate use w/17-150C on tilt columns 11/16 horn button shaft [not in 17-150B] **16.75**

17-150E TURN SIGNAL CANCELING CAM w/Horn Contact Plate use w/17-150C on tilt columns 7/8 horn button shaft [not in 17-150B] **12.00**

17-150C HORN CONTACT KIT, adjustable length button, tension spring & retainer to fit to 17-150D or E for tilt columns **6.75**

17-150B Stock Steering Wheel to Tilt Column HORN KIT [also for downsized wheels] horn contact spring, pin, retainer, horn ring spring + filler ring for bottom of wheel to fill the space between early wheel and a late column **43.00**

17-150G1 Flaming River Column Horn Contact Wire **27.00**

STEERING WHEELS

Choosing a Steering Wheel Notes: Original Wheels are 4-3/4 deep bottom of hub to front of wheel, this is the 'Dish'. As specified wheels it includes the wheel and the style sleeve or hub. Note the dish specified. Tilt columns are longer than stock. 57 especially since they are 2" longer than stock and you can make up for this by choosing a flatter wheel.



17-070 55-6 Bel Air



17-073 57 Bel Air & 210

Stock 18" STEERING WHEELS
Bare Wheel, Black Finish, Original Dimensions, Each **\$225.00**



30-RP20001 55-6 Bel Air 3 spoke
30-RP20003 58-60 Bel Air



30-RP20002 57 Bel Air 2 spoke

DOWN SIZED STEERING WHEELS
15" wheels by AMERICAN-RETRO

Complete with horn ring & trim. Wheel color is black only, paint to your color. Note that the finish quality is better than it was earlier but for show the chrome parts may need to be rechromed if you want them perfect. The wheel itself may need some finish attention before painting. **\$379.00**

NOW AVAILABLE Custom *Lecarra & Con2R* Steering Wheels see their web sites choose your style...choices are endless
Made in the USA

GRANT STEERING WHEELS call for other styles.

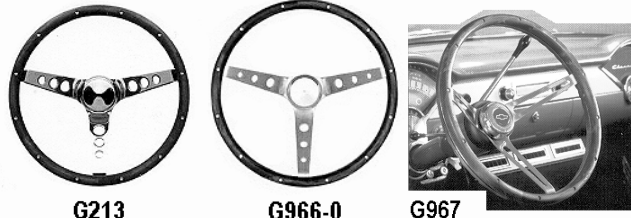

- G213** 13.5" Dia. 3.75" Dish Classic Nostalgia **166.00**
- G966-0** 15 x 4 1/8 Dish Wood Brushed SS Spokes Classic Nostalgia **199.00**
- G967** 15 x 4 1/8 Dish Wood Brushed SS Spokes Classic Nostalgia **199.00**
- G967-0** 15" Dia. 4-1/8" Dish 3 Brushed Stainless Slotted spokes, Walnut hardwood grip, Classic Nostalgia **209.00**
- G969** 15" Dia. 4-1/8" Dish 3 Brushed Stainless Slotted spokes, Black foam cushion grip, Chevrolet Horn Button, Classic Nostalgia **169.00**
- G969-0** 15" Dia. 4-1/8" Dish 3 Brushed Stainless Slotted spokes, Black foam cushion grip, Chrome Horn Button, Classic Nostalgia **169.00**



- G1070** 14.5" Dia. 2.75" Dish Black Leather grip Le Mans series S/O **259.00**
- G1071** 14" Dia. 3.75" Dish Mahogany grip Le Mans series S/O **290.00**

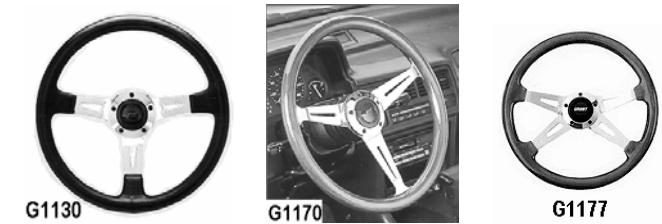

- G1130** 14" Dia. 3.75" Dish Polish Blk Leather grip, Collectors edition **259.00**
- G1170** 14.5" Dia. 3" Dish Polished Aluminum Mahogany grip Collectors edition **299.00**
- G1177** 14.75" Dia. 3-3/4" Dish Polished Aluminum Mahogany grip Collectors edition **386.00**

Call for other Grant wheels

Grant Steering Wheel Adapters

- G3162** 57-68 column, can use on 55-6 with 21-239 **34.00**
- G3196** 69-94 column, such as our tilt columns **34.00**
- G4160** 55-56 column **39.00**



- Billet Installation Kit 2" tall
Signature series,
Wheels 55-94 Columns
- G51961** Polished **85.**
 - G5196** Black **85.**

Optional Horn Caps/Buttons call for others

- G5894** Chromed Aluminum Plain no logo for Classic & Challenger Series. Adhesive/Snap-On type **18.00**
- G5644** Stainless Steel center painted blue w/ white Bowtie outlined for Classic & Challenger Series. Adhesive/Snap-On type **22.00**
- G5643** Stainless Steel center painted red white blue outer accents w/ Silver Bowtie in black center for Classic & Challenger Series. Adhesive/Snap-On type **36.00**
- G5640** Chromed Steel center painted black w/red Bowtie outlined for Classic & Challenger Series. Adhesive/Snap-On type **21.00**

Note Deep dish Wheels are not recommended for Tilt Columns
Any 2.75" dish or higher can only be used on stock column

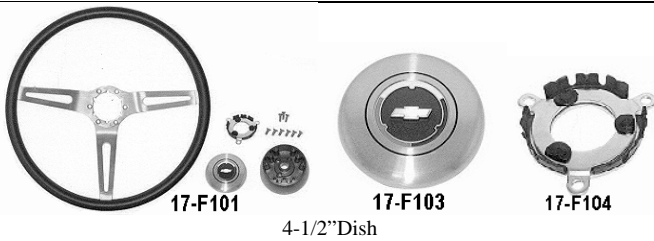

4-1/2" Dish

Repro 67-72 Accessory 'Comfort Grip' Steering Wheel

- 17-F100** Black Steering Wheel KIT for 67-68 column **250.00**
- 17-F101** Black Steering Wheel KIT for 69-72 column [this will fit our tilt columns] **250.00**
- 17-F102** 67-72 'Comfort Grip' Black Wheel only **159.00**
- 17-F103** 67-72 Horn Cap [wood or comfort grip] **35.00**
- 17-F104** 64-72 Horn Contact Plate [wood or comfort grip] **19.00**
- 17-F105** 67-68 Hub 3-15/16 Dia x 1-7/8 Tall **39.00**
- 17-F106** 69-72 Hub 4-1/8 Dia x 1-3/16 Tall **39.00**



'Waterfall'

Flaming River call for others

- FR20150** Waterfall Steering Wheel hand stitched Black Leather 13.8" diameter **499.00**
- FR20150HGAD** Waterfall Wheel Adapter 2-1/2" tall **163.**

- FR20152BK** 15" dia 6 bolt chrome hand stitched black leather, also available lite gray [LG], red, [RE] includes horn button **\$522.97**
- FR20151HRN** Horn Button Assembly **\$199.00**
- FR20157SS** Rounded top edge 5/6 bolt pattern 1-13/16" tall **\$199.00**



FR20152BK
FR20157SS

Cruise Control by Dakota Digital



- CRS-2/HND-2 w/Dash Switch for cable driven speedo **329.00**
- CRS-2/HND-3 w/Column Switch for cable driven speedo **329.00**
- CRS-3/HND-2 w/Dash Switch for electric speedo **279.00**
- CRS-3/HND-3 w/Column Switch for electric speedo **279.00**
- CRC-1000-3 LS drive by wire w/all OEM control components plugs-in, w/Column Switch for aftermarket columns **395.00**
- DAK-HND-2 Dash mount Switch can be secured under or on dash. Measures 2"x 1-3/8" ordered separately **53.00**
- DAK-HND-3 Column Lever Switch replaces signal lever, early GM, & many aftermarket columns attaches with single screw. **42.00**
- DAK-SEN014160 Double ended pulse generator **44.95**
- DAK-SEN4165 Magnetic Pickup COIL **37.95**

Grp 18A Weatherstripping

All **Made in USA** when available. All weatherstripping is highest quality sponge rubber w/smooth black skin & molded in clips where original.

WEATHERSTRIP KITS Includes All Weatherstrip items for Doors, Trunk or Tailgate; Door W/S, Windshield Pillar, Qtr Window Verticals (plain), Door 'J's, all Tailgate or Trunk W/S. Call for other Variations by Danchuk & other substitutes not shown here.

Call for pricing

- 18-050 55-6 2 dr Ht/Cv
- 18-050D 55-6 2 dr Ht/Cv Danchuk
- 18-051 57 2 dr. HT/Cv
- 18-052 55-7 Nomad
- 18-053 55-6 2 dr Sedan
- 18-054 57 2 dr Sedan
- 18-055 55-6 4 dr Sedan
- 18-056 57 4 dr Sedan
- 18-057 56 4 dr HT Includes door rubbers without molded ends
- 18-057M 56 4 dr HT Includes door rubbers with molded ends
- 18-061 55-7 Sdn Deliv.
- 18-058 57 4 dr HT Includes door rubbers without molded ends
- 18-058M 57 4 dr HT Includes door rubbers with molded ends
- 18-059 55-7 2 dr Wgn.
- 18-060 55-7 4 dr Wgn.

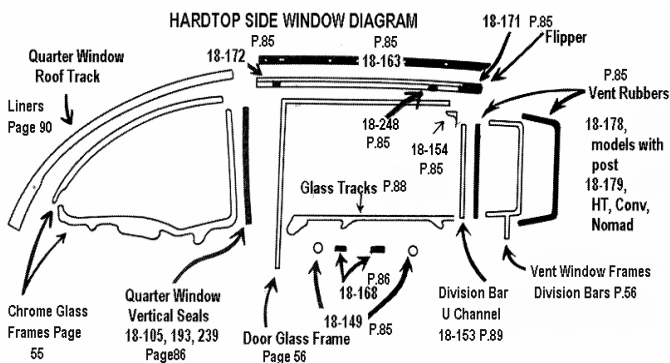

DOOR Weatherstrip

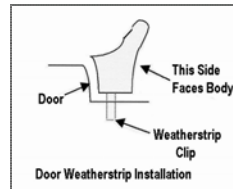

- SEDAN:** 2dr/4dr Sedan, Wagon, Sedan Delivery, 4 dr HT without molded ends (fold ends over), Pair. R
- 18-100SD Each for 1 door **27.75 R**
 - 18-100-PR Pr Clesters **79.00 R** 18-100D Pr Danchuk **74.00 R**
 - 18-100-PRSS Pr Soffseal **86.95 RF** 18-100GS Pr Golden Star **52.95 RF**
 - 18-101 2 dr. HT & Convertible, molded ends Pr. Soffseal **73.95 RF**
 - 18-101C 2 dr. HT & Convertible, molded ends Pr. Clesters **81.00 R**
 - 18-101D2 2 dr. HT & Convertible, molded ends Pr. Danchuk **129.00 R**
 - 18-106 Nomad, molded ends, Pr. Soffseal **107.95 RF**
 - 18-106A 4 dr HT, molded ends, Front Dr. Pr. Soffseal **94.95 RF**
 - 18-106B 4 dr HT, molded ends, Rear Dr *N/A Use 18-100 trim & fold*
 - 18-103 Windshield PILLAR POST Weatherstrip all HT, Conv. & Nomad, Pr. **11.95 R**

Front Door Hinge 'J' Weatherstrip 'J' RUBBERS)



- 18-185 Pr. w/clips Soffseal **28.95 R**
- 18-185D Pr. w/clips Danchuk **19.00 R**
- 20-207 Door W/S FORK Clip Pr front of door 53-60 **3.00 R**
- 20-207A Wagon Tailgate Weatherstrip FORK Clip set of 5 w/stainless screws **7.00 R**

TRUNK Weatherstrip

- 18-107 55-6 Clester USA **24.00 R**
- 18-107D 55-6 Danchuk USA **37.00 R**
- 18-107F 55-6 Golden Star **30.00 RF**
- 18-107SS 55-6 Soffseal **29.95 RF**
- 18-108 57 w/clips Clester USA **32.00 R**
- 18-108D 57 w/clips Danchuk USA **38.00 R**
- 18-108F 57 w/clips Golden Star **37.00 RF**
- 18-108SS 57 w/clips Soffseal **31.00 RF**



WAGON TAILGATE & LIFTGATE Weatherstrip

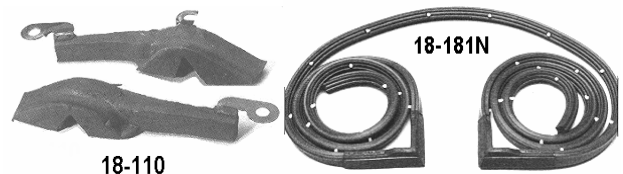

- 18-109A Liftgate Nomad, on body no corners Danchuk **38.00 R**
- 18-109 Liftgate Nomad, on body no corners Soffseal **43.95 R**
- 18-197 Liftgate Nomad, glues on top of gate, an extra seal to help solve leak problems **4.50 RP**
- 18-237 Liftgate Wagons exc. nomad molded corners Soffsl **92.95 R**
- 18-181D Liftgate Wagons, Tailgate Wagon & Nomad no corners **39. R**
- 18-181N Tailgate Nomad molded corners Soffseal **88.95 R**
- 18-181W Tailgate Wagons exc. nomad molded corners Soffsl **87.95 R**
- 18-110 Tailgate TABS, Nomad, molded rubber over metal, 3" long, screws to Liftgate, Pr. **23.00 R**



18-111

NOMAD ROOFRAIL Weatherstrip

Screws to roof, door glass closes against it.
Solid steel backbone, holes not molded into rubber,

- 18-111 Danchuk Pr. **199.00 R**
- 18-111A Soffseal Pr. **224.95 R**

56-7 4 Dr HT ROOFRAIL Weatherstrip

Mounts to roof, door glass closes up against it

- 18-198 ROOFRAIL Weatherstrip, Pr. no cloth cover T&N **325.00 R***
- 18-198C ROOFRAIL with cloth cover pr [Clester] **399.00 R***
- 18-198A Roofrail STOPS, 56-7 4 Dr HT, Pr. **16.00 R**

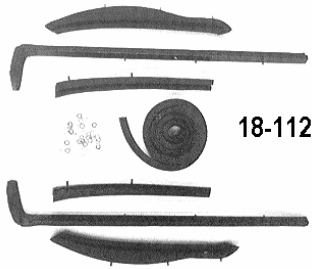

18-112

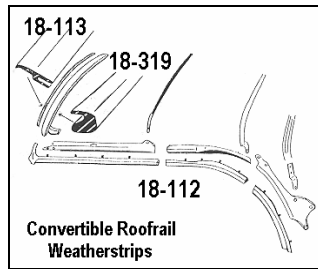

Convertible Roofrail Weatherstrips

CONVERTIBLE ROOFRAIL Weatherstrip

Cloth covered rubber molded over metal backbone that bolts to top side rails to seal side windows & seal top of windshield frame, 8 piece set

- 18-112 Cv. ROOFRAIL Kit w/cloth cover Clester **440.00 R**
- 18-1122 Cv. ROOFRAIL Kit w/cloth cover Soffseal **379.95 RF**
- 18-1123 Cv. ROOFRAIL Kit No cloth cover Soffseal **384.95 RF**
- 18-113 HEADER FLAT SEAL, front of Convertible Top, covers tack strip, Ea. (part of 18-112) **15.75 R**
- 18-319 HEADER SPONGE SEAL, Convertible Top front (part of 18-112) **13.90 R**
- 18-320 ROOFRAIL STOPS, for Convertible Top side folding rail, Pr. **8.90 R**



NEW 2 Dr HT FLIPPER Assemblies

12-670B 56-57 2 SPRING TYPE Pr. 55 replacement [55 originals had 3rd spring, that was not necessary and removed in '56] **327.95 RF**

PARTS to Rebuild Your Own Flippers.

- 18-008-BO FLIPPER OVERHAUL KIT, 55, Includes 18-163D, -171A, -171F, -172D, -248, 4/18-321; 20-437, -573, -187B **135.55**
- 18-009-BO FLIPPER OVERHAUL KIT, 56-7, Includes 18-163D, -171A, -171F, -172D, -248, 4/18-321; 20-282, -573, -187B **134.50**

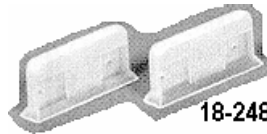

18-248 Flipper Lever PLASTIC COVER All 2 Dr HT, Pr. **8.00 R**

18-248

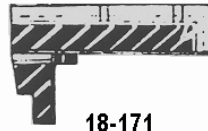

18-171

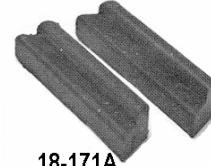

18-171A



18-172

FLIPPER ASSEMBLY RUBBERS

- 18-163 SEALS to ROOF, 2 dr HT, Pr. T&N **22.00 R**
- 18-163D SEALS to ROOF, 2 dr HT, Pr. Danchuk **23.00 R**
- 18-171 FRONT STOP/SEAL, 2 dr. HT, Pr. T&N N/A Use 18-171F
- 18-171F FRONT STOP/SEAL, 2 dr. HT, Pr. Danchuk **21.00 R**
- 18-171A FLIPPER BUMPER to Vent Window 2 dr HT front of flipper Pr. **4.00 R**
- 18-172 REAR STOP, 2 dr. HT, Pr. **17.00 R**
- 18-172D REAR STOP, 2 dr. HT, Pr. Danchuk Version **17.50 R**



18-154

DIVISION BAR STOP

Top of door glass channel. HT Conv. Nomad Pr
18-154 Danchuk **13.00** 18-154A Gene Smith **13.00**
18-154F Cal Classic Chevy **7.00**



18-178D

VENT WINDOW

Weatherstrip

Vent Frame and Division Bar parts See Chrome Frame area in Group 12 p56
Note: 18-178 & 18-179 [T&N] not available at this time

Sedans, Wagons, Sedan Delivery

HTs, Convertible, Nomad

- | | |
|---|---|
| <u>18-178</u> Clester 79.00 R | <u>18-178</u> Clester 79.00 R |
| <u>18-178D</u> Danchuk 79.00 R | <u>18-179D</u> Danchuk 79.00 R |
| <u>18-178F</u> Fargo 65.00 RF | <u>18-179F</u> Fargo 58.00 RF |
| <u>18-178F2</u> Golden Star 79.00 RF | <u>18-179F2</u> Golden Star 99.00 RF |
| <u>18-178F3</u> Cal Classic 49.95 RF | <u>18-179F3</u> Cal Classic 49.95 RF |

- 18-180 Vent Glass SETTING TAPE, enough to mount 2 **7.00 R**
Included in Danchuk sets above

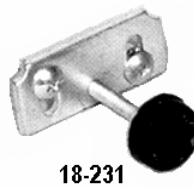

18-231

Window UPPER STOP Adjusters

Pr. for 1 door glass except rear door R

- 18-231 55-7 2 door HT, Conv. **29.00**
- 18-231B 55-7 Nomad **25.50**
- 18-231C 56-7 4d HT front door **25.50**
- 18-231D 56-7 4d HT rear door [1] **13.00**



18-149

HT, Conv, Nmd Door glass rubber Adjustable STOP COVERS,

- 18-149 Set/4 T&N **6.00 R**
- 18-149D Set/4 Danchuk **11.00 R**

- 20-187B** ASSEMBLY SCREWS Flipper & Quarter Roofrack 2 dr HT, & screws for inner qtr window to rear window trim, 40 pieces **6.50 R**
- 20-401** ASSEMBLY SCREWS Vent Window Set, 2 dr HT, Conv, Nomad, 4 dr HT, to assemble moldings, rubber & regulator, both sides **17.00 R**
- 20-402** ASSEMBLY SCREWS Vent Window Set, Sedans & Wagons except nomad **4.40 R**



Door WINDOW ROLLERS

Anti-rattle roller that goes against door glass most, not all HT, Cv, Nmd, Not really necessary if channels are good. Most 57 use only inside one.

- 18-168** Front Door Roller GROMMET, HT, Cv, Nmd, Set/4 **3.95 R**
- 18-168A** ANGLED; Screws to Exterior side of glass, Ea. **9.00 R**
- 18-168B** FLAT; Screws to Interior side of glass, Ea. **9.00 R**

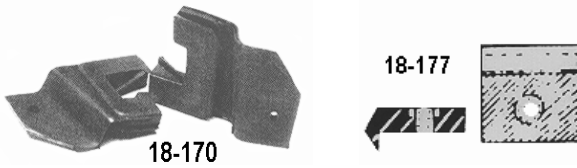

QUARTER WINDOW STOP/SEAL

Top of doorjamb on body where qtr window rests when closed

- 18-170** Hardtop, all 2 dr HT, Pr. use #18-170F **N/A**
- 18-170F** Hardtop Danchuk version of 18-170, Pr. **24.50 R**
- 18-177** Convertible, Pr. **13.90 R**

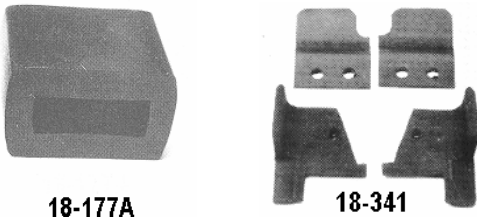

QUARTER WINDOW STOPS

- 18-177A** Convertible on qtr glass frame, Pr. **7.00 R**
- 18-341** 4 Dr. Hardtop, 56-7 Set of 4 **25.75 R**

- 18-177B** Sponge Seal Conv Top Side of rail #3 Slides into bracket on top front of rail 4" supplied enough for both sides **600 RP**



18-175

18-175 Qtr Glass 'L' STOP, 2 dr HT bolts to inner qtr. Includes bracket, square nut, bolt & lock washers. Ea. **13.00 R**

18-174A Rubber CUSHION MATERIAL for 'L' stops or other uses, 1" square fits over stop contact area. Heat shrink install **2.00 RP**



18-105

Slides into front of qtr. window; door glass closes against it,

- 18-105** PLAIN no cloth cover, HT & Convertibles, Pr. **14.95 RP**
- 18-193** Original version of 18-105 w/cloth cover & metal backing, as original, all 2 dr HT & Conv., Pr. **36.95 R**
- 18-239** 4 dr HT, w/cloth cover, 56-7, Pr. **N/A** use 18-239A
- 18-239A** 4 dr HT, plain rubber, 56-7, Pr. **20.95 R**

QUARTER WINDOW VERTICAL SEALS

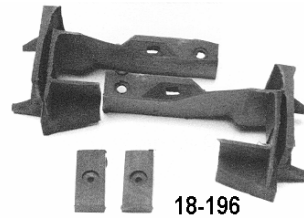

- Convertible Top DRAIN GUTTER SEALS**
- 18-196** Includes #18-320 Stops, Set of 4 T&N **N/A** use 18-196A
 - 18-196A** Pr. without the stops Danchuk **39.00 R**

Glass RUBBER CHANNELS



WINDSHIELD Rubber Channel

- 18-122** All Except Cv, 55-'150' Soffseal **89.95 RF**
- 18-122-1** 55-6 HT & Nomad Clester **56.00 R**
- 18-122-2** 57 ALL & 55-6 Sdn/Wgn except Nomad Clester **56.00 R**
- 18-122D** All Except Cv, 55-'150' Danchuk **59.00 R**
- 18-122C** All convertibles **56.00 R**
- 18-123** 55 '150' models without moldings **59.00 R**
- 18-123D** 55 '150' models without moldings [Danchuk] **57.00 R**

REAR GLASS Rubber Channel

- 18-124** 55 '150' models without moldings **65.00 R**
- 18-125** All 2 dr Hardtops **49.00 R**
- 18-125D** All 2 dr Hardtops Danchuk **52.90 R**
- 18-126** 55 Sedans (except 55 150) **49.00 R**
- 18-126D** 55 Sedans (except 55 150) Danchuk **59.00 R**
- 18-127** 56-57 4 dr Hardtop **49.00 R**
- 18-127D** 56-57 4 dr Hardtop Danchuk **68.00 R**
- 18-128** 56-57 Sedans (has extra flap covers headliner tack strip) **63.00 R**
- 18-128A** 56-57 Sedans Soffseal **69.00 RF**
- 18-128D** 56-57 Sedans Danchuk **79.00 R**
- 18-129** Tailgate Wagons & Delivery, exc. nomad **N/A R**
- 18-129A** Tailgate Wagons exc. Nomad [Soffseal] **31.99 R**
- 18-129D** Tailgate Wagons exc. Nomad [Danchuk] **29.90 R**
- 18-130** Tailgate, Nomad **N/A R**
- 18-130D** Tailgate, Nomad [Danchuk] **39.90 R**



- 20-172** Windshield MOLDING CLIPS, Set of 5 for lower moldings USA made **14.70 R**



- 20-205** Windshield Molding LOWER CORNER MOLDING CLIPS, Pr. USA made **12.50 R**



REAR WINDOW MOLDING CLIPS

- 20-143** Set of 15 Standard used originally **8.00 R**
- 20-419** Set of 22 for those who want to use more USA made **10.00 R**

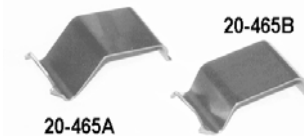

Tailgate Window CLIP SET
Wagons, Sedan Delivery except nomad, Made in USA

- 20-465** Set of 4 **24.00 R**
- 20-465A** UPPER Each **6.50 R**
- 20-465B** LOWER Each **6.50 R**

- 18-301** Qtr Glass 2 dr Sedan Stationary, business coupe, Pr. **79.90 R**
- 18-303** Center Side Window 2 dr Wagon Stationary glass, Pr. **85.00 R**
- 18-302** 4 dr Sedan, small window behind rear door, Pr. **79.00 R**

Windshield Drain Tube Set

- 23-180 55 USA **12.70 R** 23-180D 55 Danchuk **17.50 R**
- 23-181 56-7 USA **12.70R** 23-181D 56-7 Danchuk **17.50 R**

Rear Glass Drain Tube Set

- 23-207 Sedans USA **13.50** 23-207D Sedans Danchuk **17.50 R**
- 23-208 Sedans USA **13.50** 23-208D Sedans Danchuk **17.50 R**

QUARTER GLASS Rubber Channel



- 18-119D Curved Window, 2dr Wagon exc. Nmd, Pr. **79.00 R**
- 18-119A Wagon Qtr Window Front DIVIDER BAR 'FEET', set/4 top & bottom **28.00 R**



- 18-120D Curved Window, 4 dr wagon, Pr. **79.00 R**
- 18-121D Curved Window, Nomad, Pr. **79.00 R**



2nd design individual clips instead of large 1 piece type. USA made
Nomad Slider Glass Channel LOCATING CLIP

- 20-464A Each **5.00 R**
- 20-464AS SET of 6 **25.00 R**
- Wagon & Nomad Curved Qtr Glass UPPER Retaining CLIP
- 20-464B Each **6.00 R**
- 20-464BS SET of 8 **27.00 R**
- Wagon & Nomad Curved Qtr Glass LOWER Retaining CLIP
- 20-464C Each **5.00 R**
- 20-464CS SET of 10 **39.00 R**

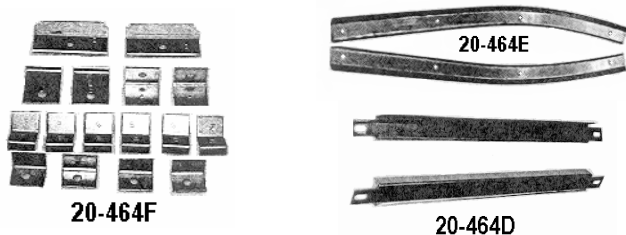

- 20-464D Nomad Upper Inside QTR GLASS BRACKETS, Pr. **53.00 R**
- 20-464E Lower Inside Qtr Glass Brackets, long curved 1 pc. Nomad Pr. **78.00 R**
- 20-464F Qtr Glass Clip Set stainless, Nomad Set of 16 **58.00 R**
See Group 20 for OTHER related fasteners



- 12-663 Nomad Slider Glass VERTICAL MOLDING Pr. **130.00 R**
- 12-664 Nomad Curved Quarter Glass FRONT MOLDING Pr. w/whiskers attached **145.00 R**
- 12-004 Nomad Slider Glass LATCH, Pr. **34.95 R**
- 12-004A Nomad Slider Glass CATCH, Pr. **25.00 R**



- 18-322 Nomad Sliding Glass SUPPORT BRACKET mounts under lower slider glass 'U' channel so it won't move by itself. Set **39.90 R**
- 23-206 Nomad Sliding Glass STOPS, Pr. **4.40 R**
- 18-338 Nomad Sliding Glass VERTICAL SEALS, Pr. **25.00 R**



Glass Setting Channels

Mounts roll-up glass in metal tracks & chrome frames, includes rubber 'U' channel & 'U' channel w/ deflector flap for all roll-up windows. All USA made.

- 18-131 HT & Convertible, **33.00 R**
- 18-131F HT & Conv., Danchuk version of 18-131 **31.00 R**
- 18-132 Nomad, does both doors **33.00 F**
- 18-132F Nomad, Danchuk version of 18-132 **31.00 R**
- 18-199 All Sedans, Wagons except Nomad, mounts glass in bottom metal tracks, N/A Use 18-199F
- 18-199F Sedans, Wgn. exc. Nmd, Danchuk version 18-199 **31.00 R**
- 18-180 Vent Glass SETTING TAPE, enough to mount 2 **7.00 R**

SEALERS & ADHESIVES



- 18-226 WINDSHIELD & REAR GLASS SEALER, caulk gun tube of correct non-hardening sealer to install glass, Ea. **9.00**
- 18-164 Weatherstrip Adhesive, 3M BLACK, bond rubber to rubber, 5 oz. tube **12.90**
- 18-164A Adhesive Sealant, Black Silicone small tube, ideal for windshield rubber to glass etc **6.00**
- 18-165 Weatherstrip Adhesive, 3M YELLOW, bond rubber to metal, etc., vinyl's to cardboard etc., 5 oz. tube **9.30**
- 18-165A Weatherstrip Adhesive, & gasket cement 3M YELLOW, rubber to metal, vinyl's to cardboard 5 oz. tube **7.50**
- 18-166A SPRAY Adhesive, 3M, 17oz. spray can (yellow) **35.00**

Grp 18B

Metal Glass Tracks

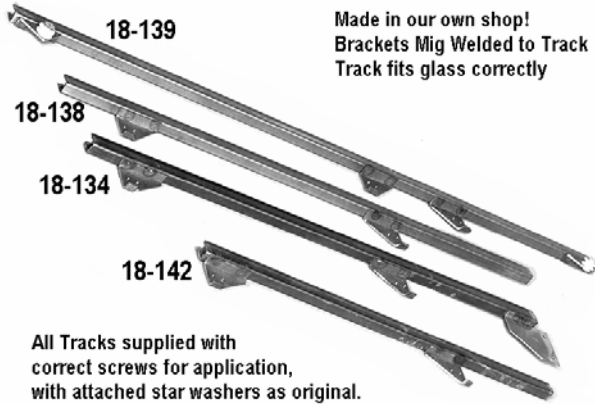

Made in our own shop!
Brackets Mig Welded to Track
Track fits glass correctly

All Tracks supplied with correct screws for application, with attached star washers as original.

2 Dr., Door Glass Bottom Tracks R

<u>18-133</u>	2 dr HT & Convertible, Left	32.00
<u>18-134</u>	2 dr HT & Convertible, Right	32.00
<u>18-135</u>	Nomad, Left	32.00
<u>18-136</u>	Nomad, Right	32.00
<u>18-137</u>	2 Dr Sdn., Wgn. & Sdn Del, Left	26.00
<u>18-138</u>	2 Dr Sdn., Wgn. & Sdn Del, Right	26.00

Quarter Glass Bottom Tracks R

<u>18-139</u>	2 Dr Sedan, Left	44.00
<u>18-139A</u>	2 dr Wagon, Left	30.00
<u>18-140</u>	2 Dr Sedan, Right	44.00
<u>18-140A</u>	2 dr Wagon, Right	30.00



Convertible Quarter Window Glass Tracks

Convertible Quarter Glass Tracks

<u>18-133C</u>	Pair USA stainless steel	300.00 R
<u>18-133AF</u>	Left Each foreign made	157.95 RF
<u>18-133BF</u>	Right Each foreign made	157.95 RF

4 Door Glass Bottom Tracks R

<u>18-141</u>	4 Dr Sedan, Wagon, front door, Driver side	26.00
<u>18-142</u>	4 Dr Sedan, Wagon, front door, Right side	26.00
<u>18-143</u>	4 Dr Sedan, Wagon, rear door, Drivers side	26.00
<u>18-144</u>	4 Dr Sedan, Wagon, rear door, Right side	26.00

20-317 GLASS TRACK SCREWS, for attaching track to regulator roller guides, Pack/10, plated, phillips with star washers **4.40 R**



18-138T

Glass Track ROLLER GUIDES R

Screws to glass track, window regulator rollers slide into them

<u>18-138T</u>	Front Door all 2 dr. Ea.	21.95
<u>18-139T</u>	Rear Quarter 2 dr Sdn. Ea.	19.60
<u>18-141T</u>	Front Door 4 dr. Sdn. and Wagon, Ea.	33.00
<u>18-143T</u>	Rear Door 4 dr. Sdn. and Wagon, Ea.	33.00
<u>18-138T1</u>	Regulator Idler Roller Guide screws to door all front doors 6-5/8" long welded nut on each end	20.00



20-206

20-206 DOOR JAMB SCREWS & OVAL WASHER SET, for rear vertical glass track rear of door HT/CV/Nomad **17.00 R**

<u>18-148</u>	GASKET Door Jamb Chrome Oval Washer, HT, CV., NMD., Each	1.50 R
<u>18-151</u>	Door Rr Vertical channel Liner <u>HT, Conv.</u> , 1 pc. for 1 door	19.00
<u>18-151A</u>	Door Rr Vertical channel Liner <u>Nomad.</u> , 1 pc. for 1 door	20.00

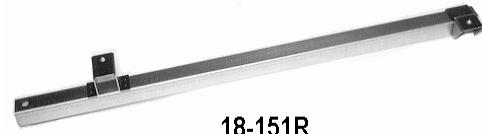

18-151R

VERTICAL GLASS RUN CHANNEL

Use with 18-151 Liner, Rear of Door USA **Each**

2 dr HT, Cv	<u>18-151L</u> Drivers Side	<u>18-151R</u> Pass. Side	\$40.
Nomad	<u>18-151LN</u> Drivers Side	<u>18-151RN</u> Pass. Side	\$49.

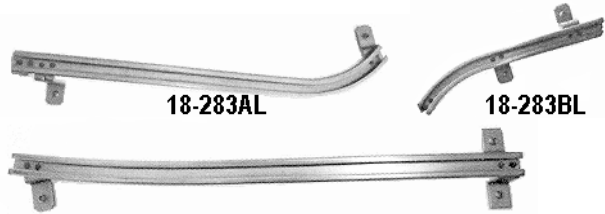

18-283AL

18-283BL



18-284BR

18-284AR

Quarter Glass ROLLER GUIDES Screws to inner body, window rollers slide in them

<u>18-283AL</u>	2 dr. HT Long Drivers Side Ea.	48.00 R
<u>18-283AR</u>	2 dr. HT Long Passengers Side Ea.	48.00 R
<u>18-283BL</u>	2 dr. HT Short Drivers Side Ea.	38.00 R
<u>18-283BR</u>	2 dr. HT Short Passengers Side Ea.	38.00 R
<u>18-284AL</u>	2 dr. Sedan Long Drivers Side Ea.	48.00 R
<u>18-284AR</u>	2 dr. Sedan Long Passengers Side Ea.	48.00 R
<u>18-284BL</u>	2 dr. Sedan Short Drivers Side Ea.	38.00 R
<u>18-284BR</u>	2 dr. Sedan Short Passengers Side Ea.	38.00 R



18-176

18-176 Qtr Glass Roller Guide Track 'L' STOP, 2 dr sedan & 2 dr HT Includes bracket, square nut, bolt, lock washers. Ea. **14.00 R**



20-401R3

20-401R3 Quarter Glass Roller Guide TRACK ADJUSTER, 2dHT, Each **9.00 R**

Door Glass Bottom STOP

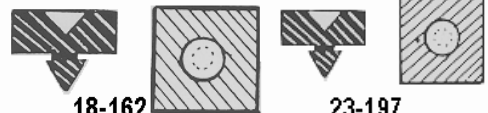

18-162

23-197

Large square bumper, bottom of door, glass track rests on.

<u>18-162</u>	HT, Conv., Nomad, & 2dr wgn qtr glass Ea.	N/A R
<u>18-162D</u>	HT, Conv., Nomad, & 2dr wgn qtr glass Ea. Danchuk	8.00 R
<u>23-197</u>	Sdn/Wgn exc. Nomad, (1 per door) Ea.	2.00 R



18-325



18-325A1

Window Regulator
and Frame
Roller and Rivet

- 18-325** 1 roller, 1 rivet (fits 1/4" hole) Replacement **3.00 RP**
18-325A1 1 roller, 1 rivet (fits 5/16" hole) Original diameter fits most original applications, quarter glass frames etc **4.00 R**
18-325B 1 roller, 1 rivet (fits 3/16" hole) 4 Dr HT Window Regulator Small Roller & Rivet 11/32 dia roller **4.00 R**

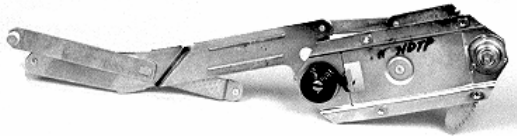

18-270

DOOR WINDOW REGULATORS

- 18-270** 2 Dr Hardtop / Convertible, LEFT **129.95 RF**
18-271 2 Dr Hardtop / Convertible, RIGHT **129.95 RF**
18-272 2 Dr Sedan / Wagon / Nomad, LEFT **129.95 RF**
18-273 2 Dr Sedan / Wagon / Nomad, RIGHT **129.95 RF**
18-273KS 2 Dr Sedan / Wagon / Nomad, RIGHT **100.00 RF**
18-282L 56-7 4 Dr HT Front Door Left **139.95 RF**
18-282R 56-7 4 Dr HT Front Door Right **139.95 RF**



18-279

VENT WINDOW REGULATOR

- 18-278** 55-7 All LEFT **.95.00 RF**
18-278A 55-7 All LEFT [GS] **.99.00 RF**
18-279 55-7 All RIGHT **.95.00 RF**
18-279 55-7 All RIGHT [GS] **.99.00 RF**



18-276

QUARTER WINDOW
REGULATOR RF

Each **114.00** Convertible **119.95**
Window Cranks see Group 12 Page 67

- 18-274** Hardtop 2 Dr LEFT **18-275** Hardtop 2 Dr RIGHT
18-276 Sedan 2 Dr LEFT **18-277** Sedan 2 Dr RIGHT
18-280 Convertible LEFT **18-281** Convertible RIGHT



20-394



20-496S

20-496S Square CAGED NUT, replaces pressed nuts in door & inner body to attach window regulators, door handle mechanisms snaps in square hole, Set/6 **4.50 RP**

20-394 WINDOW REGULATOR SCREWS, 55-64, Pack of 8, also used on door handle inside mechanism & other door hardware **6.00 R**

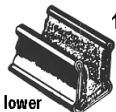

lower



upper

The original way the division bar was done with these 2 pieces.



18-160 60"
18-161 72"

Original stainless beaded U channels supplied formed. Flexible U channel is easily formed & gives a cleaner look [18-160A]

Side Window Glass Channels

Individual Items

'U' CHANNELS USA made materials

Bright stainless Beaded except 18-160A, for all Sedans, Wagons, Sedan Delivery and other models as required

- 18-153** RIGID 'U' Channel, Vent Window Division Bar, all models, 2 pieces for 1 side w/rivets, for roll up glass side of division bar **22.00**
18-160-Form Front door 2 or 4 dr Ea. fully shaped **60.00**
18-161-Form Qtr Window 2 dr Sedan Ea. fully shaped **60.00**
18-161B-Form 4 dr Wagon Rear Door Ea. fully shaped **65.00**
18-161B1-Form 4 dr Sedan Rear Door Ea. fully shaped **65.00**
18-160A Flexible no stainless bead 96" long all applications Ea. **70.00 C**
18-221 Quarter Window, Convertible, Each. 2 required **46.00**
18-150 Nomad SLIDING GLASS 'U' CHANNEL, All 4 pieces bright beaded 'U' channel for both quarter panel sliding windows not formed strait lengths [included in 18-219] **170.00**



18-159A



18-159B

18-159A U Channel GUIDE, goes on bottom end of glass run channel inside Sedan door, shorten for 4 dr or 2 dr Qtr window, Ea. **11.00 R**

27-168 Anchor Bolt Set for 2 of 18-159A above **6.00 RP**

18-159B U Channel GUIDE 2 dr Sedan Quarter Window Front, 11-3/4" long, steel Pr. **19.00 R**

Channel Kit Fastener Sets ONLY

- 18-227** 2 & 4 Dr Sedan Rp. 94pc **15.00**
18-227A Sedan frt drs only Rp., B/A 82pc **10.00**
18-227B 2 Dr Sedan Original, B/A 118pc **39.00**
18-227C 4 Dr Sedan Original, B/A 118pc **38.00**
18-228 Sedan Rp., 2 & 4 Dr '210' & '150' Discontinued Use 18-227
18-228A Sedan front doors only Rp., '210' & '150' Use 18-227A **66.00**
18-228B 2 Dr Sedan Original, '210' & '150' 55-7 **66.00**
18-228C 4 Dr Sedan Original, '210' & '150' 55-7 **66.00**
18-229 2 Dr HT & Cv. 55-7 **8.00**
18-230 4 Dr HT & Cv. 55-7 **7.70**
18-230A Nomad 55-7 **7.00**

Complete Door Glass Beaded Channel Runners
w/clips and metal guides installed & formed. Pr F



18-501

18-501 Door Window 2d Sedan or Wagon except Nomad Assembled Pr. **255.00* RF**



18-502

18-502 Quarter Window, 2d Sedan Assembled Pr. **255.00* RF**



18-504

18-503 Front Door Window 4d Sedan or Wagon except Nomad Assembled Pr. **204.00* RF**

18-504 Rear Door Window 4d Sedan Assembled Pr. **204.00* RF**



FORMED FLAT WHISKER STRIP SETS

For belt moldings & garnish moldings. Included in kits where specified. Correct shapes & trimmed ends to fit to & under 'U' channels. No one else takes the time to trim and shape these like we do.

<u>18-342</u>	55-6 2 dr HT, 4 piece set quarter windows	58.00
<u>18-343</u>	55-6 Convert., 4 piece set quarter windows	58.00
<u>18-344</u>	57 2 dr HT, 6 pieces quarter and doors	87.00
<u>18-345</u>	57 Convert., 6 piece set quarter and doors	87.00
<u>18-350A</u>	2 dr Sedan, 8 piece, Bel Air	110.00
<u>18-350B</u>	2 dr Sedan, 8 piece, '210'/150'	N/A use 18-350A

FLAT WHISKER STRIPS Stainless Beaded straight lengths, not shaped 3/8" wide sold each

<u>18-223</u>	<u>19 1/2"</u>	4 Dr HT 56-7 front door	8.00
<u>18-222</u>	<u>20"</u>	4 Dr Sedan/Wagon front door	8.00
<u>18-158</u>	<u>24"</u>	HT/Cv. Qtr	9.00
<u>18-155</u>	<u>26"</u>	All 2 Dr Sedan & Wgn on door, also 57 2 dr HT/Cv. door garnish molding	10.00
<u>18-224</u>	<u>26"</u>	4 Dr. Sedan & Wagon rear door	10.00
<u>18-225</u>	<u>32"</u>	4 Dr HT 56-7 rear door	12.00
<u>18-321</u>	<u>32"</u>	2 dr HT flipper to replace entire strip	12.00
<u>18-156</u>	<u>36"</u>	All 2 Dr Sedan & Wgn Qtr. Window. inner or outer, exc. cars stationary glass	13.50

20-001D STAPLE. Window Channel Weatherstrip, Stainless Steel, Pack/20 for whisker strips, A- arm seals, tail light dust seals etc. **5.00 R**



20-001D

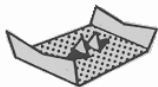

20-435



20-436



20-462A

Original GLASS 'U' CHANNEL CLIPS

<u>20-435</u>	For <u>Door</u> , models with post, 2 & 4 dr, Each	.95 R
<u>20-461</u>	Door CLIP SET, Pack of 14 20-435 does 2	11.00 R
<u>20-436</u>	For <u>Quarter</u> , models with post 2 dr, Each	1.40 R
<u>20-462</u>	Quarter CLIP SET, Pack of 20 #20-436 does 2	20.80 R
<u>20-462A</u>	REAR DOOR CLIP SET, Pack of 18, does 2 4 dr sedan / station_wagon rear doors	20.80 R
<u>20-462AEA</u>	'Clam Shell' CLIP for 4 dr sedan, Nomad qtr window & slider window end clip, Each	2.20 RP

18-151



GLASS RUN LINERS

Black mohair material to reline areas that do not take a full channel

<u>18-151</u>	Door Rr Vertical Channel Liner <u>HT, Conv.</u> , 1 pc. for 1 door	19.00
<u>18-151A</u>	Door Rr Vertical Channel Liner <u>Nomad</u> , 1 pc for 1 door 22.5"	20.00
<u>18-152</u>	Quarter Glass ROOF TRACK LINER; 2 dr. HT 1 side	24.00
<u>18-173</u>	FLIPPER MOHAIR LINER, 2 dr HT to reline existing strip, if you do not wish to replace metal backing 1 strip (does both flippers)	19.00

For other related fasteners see Group 20



20-199

Belt Flat 'WHISKER' CLIP

53-7 2 & 4 dr 210-150 Sedans & Wagons used on outside strips only

20-199EA Each **3.00** 20-199 Pk of 26 **35.00**

SIDE WINDOW GLASS Felt CHANNEL Kits

The kits below contain options. Fasteners supplied are replacement. If you wish you can order original hardware that is listed separately. If you want straight lengths that you shape yourself you may order those in most cases, see previous page or call. **Formed** kits have fully formed & correctly trimmed whisker strips & formed U channels as noted.

Unformed kits include only straight strips. All kits include original staples. All kits include replacement fasteners that consist of original type staples, special screws, rivets and instructions that are the simplest to install. No one makes them better than we do.

All Kits include Fasteners & Instructions

All channel felts still made in USA.

Flippers See Page 89

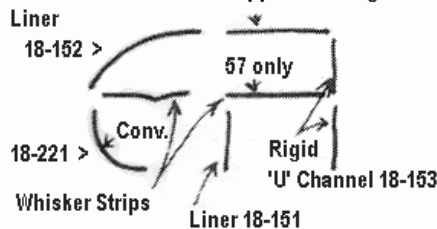

Hardtops, Convertible Window Channel

2 DR HARDTOP Channel Kit

Includes Qtr Window Roof Track Liners,

<u>18-346</u>	55-56 Kit Formed whiskers as original	143.00 R
<u>18-405-F</u>	55-56 Kit Formed whiskers all Black	143.00 C
<u>18-348</u>	57 Kit Formed whiskers as original	153.00 R
<u>18-405A-F</u>	57 Kit Formed whiskers all Black	153.00 C



18-347

CONVERTIBLE Channel Kit

Includes Qtr Window 'U' Channels

<u>18-347</u>	55-56 Kit Formed whiskers as original	199.00 R
<u>18-406-F</u>	55-56 Kit Formed whiskers all Black	199.00 C
<u>18-349</u>	57 Kit Formed whiskers as original	220.00 R
<u>18-406A-F</u>	57 Kit Formed whiskers all Black	220.00 C

56-7 4 DR HARDTOP Channel Kit

<u>18-184A</u>	Kit Formed whiskers as original	146.00 R
<u>18-408-F</u>	Kit Formed whiskers all Black	146.00 C

NOMAD Channel Kit

For Door Windows & Sliding Glass

<u>18-219</u>	Kit Unformed whiskers, Stainless beads as original	240.00 R
<u>18-407</u>	Kit Unformed whiskers, All black U channels have no beads	240.00 C

Sedan & Wagon Channel Kits

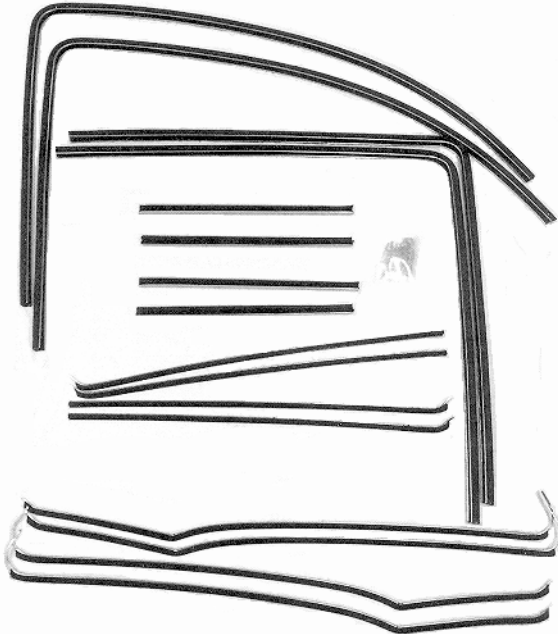

18-370A

Shipped as shown

Original Bright Beaded Kits

For 'closed' models Sedans & Wagons except Nomad. Original beaded 'U' channels with shaped corners [end trimming required] & 8 fully shaped Whiskers, replacement fasteners: screws, staples & instructions. If you want original fasteners these can be ordered separately.
All 4 windows sets include 8 whiskers, 4 U channels & 4 pc set vent division bar channels All USA made materials R

- | | |
|---|---|
| <u>18-370A</u> 2 Door Sedan \$309. | <u>18-370B</u> 4 Door Sedan \$322. |
| <u>18-370C</u> 2 Door Wagon \$322. | <u>18-370D</u> 4 Door Wagon \$345. |

18-370E 2 Door Sedan or Wagon & Sdn Delivery Doors only 4 whiskers, 2 U channels, 4 pc set vent division bar channels **\$214. R**

CUSTOM All Black Kits

No stainless beads All black. Ideal for modified cars. All flat whiskers supplied shaped & ready to install. U channels are very flexible, easy to form. Gives a clean smooth uncluttered look and a much easier installation.
All 4 windows sets include 8 whiskers, 4 U channels & 4 pc set vent division bar channels. All USA made materials

- | | |
|---|---|
| <u>18-390A</u> 2 Door Sedan \$418. | <u>18-390B</u> 4 Door Sedan \$418. |
| <u>18-390C</u> 2 Door Wagon \$418. | <u>18-390D</u> 4 Door Wagon \$429. |

18-391C Un Formed NO Bead Side Window Channel Kit 2d or 4d Sedan/Wagon without vent windows all black channels & whiskers, no stainless beads **\$199.**

18-391A Formed NO Bead Side Window Channel Kit 2d Sedan without vent windows all black channels & whiskers, no stainless beads **\$429.**

Grp 18C

GLASS

WINDSHIELDS

Drop Ship are plus Truck Freight charges.

Windshields are available in Clear also. Prepaid Special Order Only...

55-56: 2&4 Dr Sedans and Wagons, Sdn Delivery

		Pick Up	Drop Ship
<u>18-W394</u>	Tint, w/Shade Band	\$239	\$219.
<u>18-W394G2</u>	Lite Gray, w/Shade Band	\$239.	\$219.

55-56: 2&4 Dr HT, Convertible, Nomad

<u>18-W396</u>	Tint, w/Shade Band	\$239.	\$219.
<u>18-W396G2</u>	Lite Gray, w/Shade Band	\$264.	\$244.

57: 2&4 Dr HT, Convertible, Nomad

<u>18-W512</u>	Tint, w/Shade Band	\$239.	\$219.
<u>18-W512G2</u>	Lite Gray, w/Shade Band	\$264.	\$244.

57: 2&4 Dr Sedans and Wagons, Sdn Delivery

<u>18-W513</u>	Tint, w/Shade Band	\$239.	\$219.
<u>18-W513G2</u>	Lite Gray, w/Shade Band	\$264.	\$244.

REAR Glass 2d HT

REAR Glass SEDAN

Drop Ship are plus Truck Freight charges.

<u>18-310</u> 2 Dr HT Clear	\$299.	<u>18-361</u> All Sedans Clear	\$299.
<u>18-311</u> 2 Dr HT Tint	\$299.	<u>18-360</u> Sedan Tint	\$299.
<u>18-311G</u> 2 Dr HT Gray	\$319.	<u>18-360G</u> Sedan Gray	\$299.

Wagon TAILGATE Glass **\$239.* Ea**

<u>18-211C</u> Tailgate, Nomad Clear	<u>18-220C</u> Wagon exc. Nmd Clear
<u>18-211T</u> Tailgate, Nomad Tint	<u>18-220T</u> Wagon exc Nmd Tint
<u>18-211G</u> Tailgate, Nomad Gray	<u>18-220G</u> Wagon exc Nmd Gray

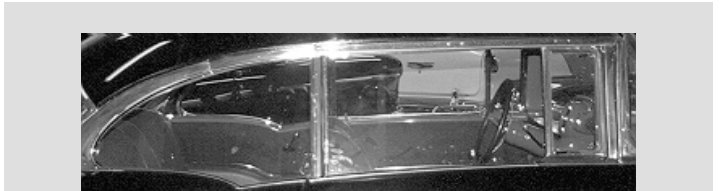

Chrome Side Window Frame ASSEMBLED SETS

Includes Vent, Door & Quarter glass Chrome frames with Glass assembled & ready to install in your car. Driver quality. Ready to install in your car.
6 pc Set Driver quality. **\$899. R**

<u>12-670T</u> 2d HT Tinted	<u>12-672T</u> Convertible Tinted
<u>12-670G</u> 2d HT Gray	<u>12-672G</u> Convertible Gray
<u>12-670C</u> 2d HT Clear	<u>12-672C</u> Convertible Clear

2 Dr. SEDAN ASSEMBLED SIDE GLASS SET

Glass mounted in glass tracks, chrome vent frames [with latches] assembled and ready to install [door glass rubbers do not have flaps]
6pc set Pair of each Vents, Doors & Quarters. Driver quality.

<u>12-675T</u>	2 Dr. SEDAN Tinted 6 pc set	\$409. R
<u>12-675G</u>	2 Dr. SEDAN Gray 6 pc set	\$429. R
<u>12-675C</u>	2 Dr. SEDAN Clear 6 pc set	\$409. R

ORIGINAL DATE CODED MARKED GLASS*

You only need date coded glass if you are building a maximum point Show Car for judging purposes at Classic Chevy Club meets. AACA is not concerned with this. For most cars use the glass as listed on these pages. If you still want date coded glass it must be special ordered to your VIN specifications and is not returnable. Fax, Mail or Email model info & VIN#. We will quote pricing & delivery time.

FLAT SIDE GLASS SETS 2 vents, 2 doors, 2 Quarters or rear doors on 4 dr 6 pc sets **SAVE w/Sets!! \$275. & up**

Side Glass SPECIFY: C [Clear], T [Tint], G [Gray], at end of part number

DOOR Glass \$69.00 Each

<u>18-201</u> 4 Dr Sdn/Wgn Front	<u>18-202</u> 4 Dr Sdn/Wgn Rear
<u>18-200</u> 2 Dr Sedan/Wagon/Delivery	<u>18-203</u> 4 Dr. Wagon Rear
<u>18-207</u> Nomad	<u>18-212</u> 2 Dr. HT/Convertible
<u>18-215</u> 4 Dr. HT Front	<u>18-216</u> 4 Dr. HT Rear

DOOR Glass Vent Window Removed \$95. Each

<u>18-200NV</u> 2 dr Sedan, Wagon (exc Nomad), Delivery,	
<u>18-212NV</u> 2 dr HT, Convertible	Call for Other Models

QUARTER Glass \$69. Each

<u>18-204</u> 2 Dr Sedan [Roll-Up]	<u>18-205</u> 2Dr Wagon [Roll-Up]
<u>18-204S</u> 2 Dr Sedan [Stationary]	<u>18-205S</u> 2Dr Wagon [Stationary]
<u>18-206</u> Small Qtr, 4 Dr. Sdn	<u>18-208</u> Nomad Slider Glass \$79.00
<u>18-213</u> 2 Dr. HT	<u>18-214</u> Convertible

Stationary Quarter Glass is also available call

Vent Glass \$27. Each [Gray \$35.]

<u>18-217</u> Sdn/Wag/S.D.	<u>18-218</u> HT, Cv., Nmd
----------------------------	----------------------------

Nomad Curved Qtr Glass \$225.* Ea

<u>18-209C</u> Clear, Left	<u>18-210C</u> Clear, Right
<u>18-209T</u> Tint, Left	<u>18-210T</u> Tint, Right
<u>18-209G</u> Gray, Left	<u>18-210G</u> Gray, Right

Wagon Curved Qtr Glass (exc. Nomad) \$225.* Ea

2 Dr Wagon		4 Dr Wagon	
Left	Right	Left	Right
<u>18-257C</u> Clear	<u>18-258C</u> Clear	<u>18-259C</u> Clear	<u>18-260C</u> Clear
<u>18-257T</u> Tint	<u>18-258T</u> Tint	<u>18-259T</u> Tint	<u>18-260T</u> Tint
<u>18-257G</u> Gray	<u>18-258G</u> Gray	<u>18-259G</u> Gray	<u>18-260G</u> Gray



Reproduction POWER WINDOW Complete Sets; Switches, Harness, lifetime warranty Motors, Regulators, etc.

<u>19-PWC4</u> Convertible 4 window Set	749.00
<u>19-PWH4</u> 2 Dr HT 4 window Set	749.00
<u>19-PWS4</u> 2 Dr Sedan 4 window Set	749.00
<u>19-PWS4-4</u> 4 Dr Sedan 4 window Set	749.00
<u>19-PWN2</u> Nomad/2d Sedan front 2 window Set	575.00
<u>19-PWH2</u> 2 Dr HT/Conv front 2 window Set	575.00

Power Window Regulators

Specify Left or Right Each

<u>19-PW5502</u> 2D HT & Convertible Door Window	199.00
<u>19-PW5503</u> 2D HT & Convertible Quarter Window	199.00
<u>19-PW5504</u> Convertible Quarter Window	199.00



19-PW5509

Power Window Switches

<u>19-PW5506S</u> Set 1-4 button, 3-1 button	200.00
<u>19-PW5506</u> 4 button	125.00
<u>19-PW5509</u> 2 button for Nomad	125.00
<u>19-PW5507</u> 1 button	60.00
<u>19-PW1605</u> Power Window Motor	99.00

19-PW5507PT Power Window Single Switch Pigtail **35.00**

19-PW5509PT Power Window 2 Button Switch Pigtail **66.00**

SPECIALTY POWER WINDOWS

Easy installation. The front door units are a straight bolt-in conversion, on 2 door Sedan & Hardtop, 2 holes have to be drilled for the quarter glass regulator (template provided). These kits all use rugged AC/Delco motors. Kits supplied with chrome switches that are similar but not exact original 55-7. **Made in USA.**



<u>19-5557SW</u> 2 Dr SEDAN/WAGON 4 Window Set	895.00
<u>19-5557N</u> 2 Window Set for Nomad, Sedan Delivery, 2 Dr Wagon or 2 Dr Sedan front only	474.00
<u>19-5557-4CVR</u> 2 Dr SEDAN <u>Vents Removed</u> 4 Window Set w/ glass template & front vertical channel	895.00
<u>19-5557-2CVR</u> 2 Dr SEDAN <u>Vents Removed</u> 2 Window Set front w/glass template & front vertical channel	474.00
<u>19-5557HT</u> 2 Dr Hardtop 4 Window Set	895.00
<u>19-5557HTF</u> 2 Window Set 2 Dr Hardtop/Conv. front only	474.00
<u>19-5557CV</u> Convertible 4 Window Set	895.00

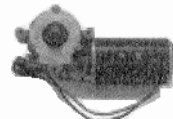

19-PW1605



19-PW5507PT

See Group 21 for related electrical parts

Grp 19A Literature & Detail Items

If you are restoring or maintaining a Classic Chevy, you can't do without a Shop Manual & an Assembly Manual. Stock or Modified, these will help avoid mistakes and save time and wasting effort.

FACTORY ASSEMBLY MANUAL: 230 pages, all detailed assembly drawings with part numbers, torque settings & RPO's, also includes production revisions made throughout the year. An absolute must for the restorer. **\$22.00 EACH**

- 19-103 55 ASSEMBLY MANUAL
- 19-104 56 ASSEMBLY MANUAL
- 19-105 57 ASSEMBLY MANUAL

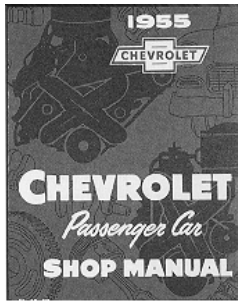
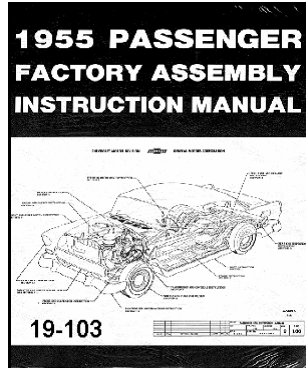

19-121

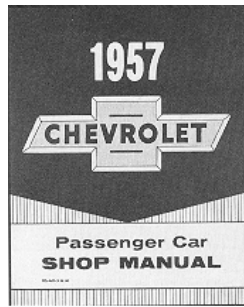

19-123

SHOP MANUALS: High quality exact reprint; explains fully thru text and illustrations every operation, overhaul & removal of mechanical, electrical & trim items.

- 19-121 55 SHOP MANUAL, over 500 pages **21.75**
- 19-122 56 SHOP MANUAL, supplement, (56 owners need both 55 & 56 manuals.) **13.95**
- 19-123 57 SHOP MANUAL, over 700 pages **28.95**

19-254 'HOW TO RESTORE YOUR '57', Classic Chevy Int. restoration guide for 57 but mostly applicable to all 3 **N/A**

19-254B 'HOW TO RESTORE YOUR '55', this is the most current manual available on the subject by Harold Louisiana; all the latest techniques for '96, shows a 55 but mostly applicable to all 3 years, 300 pages, 1800 photos **33.00**

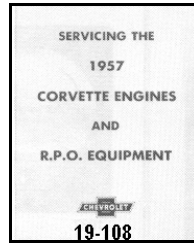

19-108 SERVICING THE 1957 CORVETTE AND RPO EQUIPMENT

This manual covers 57 'Vette and high performance options. For passenger cars; 4 speed trans, Fuel Injection & Positraction are covered in their entirety. This info is NOT found in the '57

Shop Manual, 72 full size pages as original(reprint) **12.90 R**

19-113 1957 STOCK CAR COMPETITION GUIDE

Lists all competition parts available as factory options, modifications, tuning tips, chassis tips, etc. 24 pages, exactly as original **10.00 R**

19-113A 53-63 BODY MOLDING & ATTACHING PARTS BOOK with original part numbers **15.00 R**

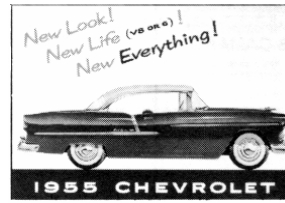
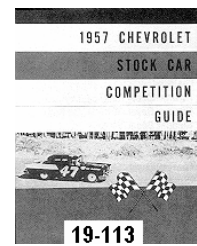

19-109



19-110

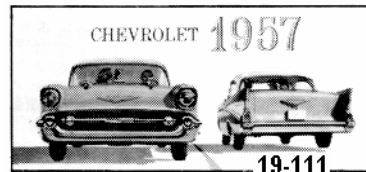

19-111

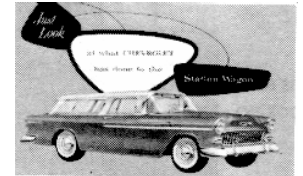

19-112

COLOR SALES BROCHURES

reprints of the original showroom brochures **\$8.00 ea.**

- 19-109 1955
- 19-110 1956
- 19-111 1957
- 19-193 1956 WAGON
- 19-112 1955 WAGON
- 19-253 1957 WAGON

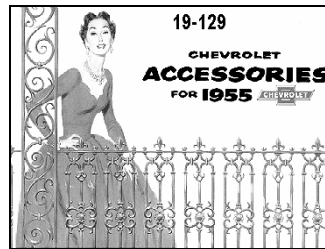

19-129



19-131

FULL COLOR ACCESSORY BOOK, each one is 32 pages long, in full color & shows all the accessories that are available for each model year. Know what accessories are recommended for various body styles & be able to identify them. A very beautiful reproduction in accurate colors.

- 19-129 1955 Full COLOR ACCESSORY BOOK **12.50**
- 19-130 1956 Full COLOR ACCESSORY BOOK **12.50**
- 19-131 1957 Full COLOR ACCESSORY BOOK **12.50**

- 19-146A 56 V8 Tune Up Guide **9.90**
- 19-147A 57 New Car Prep Guide **9.00**
- 19-248 55 Air Cond. Maintenance Manual, Part I **9.00**
- 19-249 55 Air Cond. Maintenance Manual, Part II **9.90**
- 19-249A 55-7 Air Conditioning Shop Manual, 50 pages **10.00**
- 19-249B 56 Air Conditioning Service Guide **9.00**
- 19-145A Electric Windshield Wiper Booklet 55-7 **9.95**
- 19-270 Servicing 55-7 Spherical Joint System Booklet **11.00**
- 19-271 55-7 Delco Remy 12V System Booklet **13.00**
- 19-272 Overhauling the Chevy 4 spd Trans Booklet **7.00**



DEALER ACCESSORY INSTALLATION BOOK:
complete set of installation instructions for all accessories available during the model year, shows detail illustrations with part #'s and explains how they are installed. Full size Reprint.

19-114

- 19-114 55 Accessory Installation Manual, 85 pages **14.00**
- 19-114A 56 Accessory Installation Manual **12.75**
- 19-116 57 Accessory Installation Manual, 200 pages **17.50**
- 19-214 Numerical ACCESSORY PARTS LIST, 29-78, spiral bound booklet lists all GM accessories from 29 on, including number changes, all in numerical order, now you can identify any accessory positively. Over 6000 numbers listed **19.50**



OWNERS MANUALS: exact reprint of the booklet that came in every new car.

- 19-190 55 Owners Manual **\$ 12.75**
- 19-191 56 Owners Manual **12.75**
- 19-192 57 Owners Manual **12.75**
- 19-102 Owners Manual ENVELOPE **2.75**
- 19-194 Owners Manual FOLDER / Maintenance Schedule **2.00**

19-190

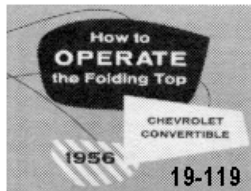

CONVERTIBLE OWNERS MANUAL:
came with every convert., in addition to owners' manual. Reprint. **\$ 7.00**

- 19-118 55 19-119 56 19-120 57

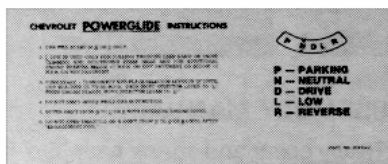

19-251

- SUNVISOR SLEEVE** Instruction on all cars when delivered new
- 19-251 Powerglide, 55-7 **7.75**
 - 19-252 Turboglide, 57 **7.75**

WIRING DIAGRAM BOOKLETS
Covers complete chassis & most accessories **\$ 6.95**

- 55 19-258 56 19-259 57 19-260

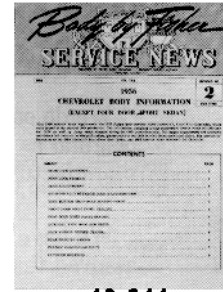

19-244

CHEVROLET SERVICE NEWS

- 19-240 **1955 #1** Complete convertible top information, electric seats, dash, doors, rear Window, trunk & RR. qtr. Info. This info is common to all 3 years. 72 pg **9.50**
- 19-241 **1955 #2** Supplementary Info to the convert. hydro-electric system. Covers changes made later in year. Info common to 55-7 convertibles. **5.00**
- 19-242 **1955 #3** Body info for all wagons Nomads, Sedan Delivery. Covers front end, doors, rr qtr, headlining, seats, rr end, electrical, & exterior moldings **10.50**
- 19-243 **1956 #1** Body info on 4 dr HT, covers all differences from other models. Applies to 57 4 dr HT also. 60 page **9.50**
- 19-244 **1956 #2** Body info regarding door latch assemblies, weatherstrip, back window rubber, rr seats & exterior moldings. **5.00**
- 19-247 **1956 #5** Rochester 4-barrel carb, service & assembly, useful for 57 also. **8.00**
- 19-247A **1956 #4** Electric Wiper Service **8.00**
- 19-262 **1956 #10** New 57 features, trim, power options, transmissions, service ops, AC compressor. 24 pages **6.00**
- 19-263 **1957 #1** Positraction; service, cleaning, assembly, installation. Fuel Injection starting procedures. Mounting 14" wheels. 4 pages **2.00**
- 19-264 **1957 #3** Preseason A/C check, Turboglide Trans changes, Spark plug replacement 55-7, Electric Wiper info, Carb trouble shooting chart, 8 pages **4.00**
- 19-265 **1957 #5** Passenger & 'Vette 4 spd trans cleaning, inspection, repair, trouble shooting, 12 pages **5.00**

- 19-261 'REGULAR PRODUCTION OPTIONS 55 CARS & TRUCKS' booklet **4.00**
- 19-133 55 SUGGESTED DELIVERED PRICE BOOKLET, original prices of options included **3.50**
- 19-134 57 SUGGESTED DELIVERED PRICE BOOKLET, original prices of options included **3.50**

- 19-136 55 ACCESSORY PRICE LISTING w/part #'s **4.00**
- 19-137 56 ACCESSORY PRICE LISTING w/part #'s **4.00**
- 19-138 57 ACCESSORY PRICE LISTING w/part #'s **4.00**

DECALS & DETAILS

DETAIL ITEMS add the finishing touch to your original or restored Chevrolet. The following items are available for **\$4.00 each** except as noted. Spend a few dollars and some time in this area. It will make a great difference in your car! Please be sure to specify year, model, V8 or 6 cyl. and body style to receive correct decals; this is important! Decals are water soluble in this section except as noted.

- 19-D012 1955 all passenger body styles jacking instruction sheet
- 19-D013 1956 all passenger body styles jacking instruction sheet
- 19-D014 1957 all passenger body styles jacking instruction sheet
- 19-D015 1957 all station wagons, Nomad, sedan del. jacking instruction sheet
- 19-D023 Additional jack stowage sheet for cars with continental kits, 1954-1960
- 19-D024 Positraction sticker for all models so equipped 1957 thru 1967



- 19-D003 1955-7 6 cyl. air cleaner decal
- 19-D004 1955-7 V8 2 brl. air cleaner decal

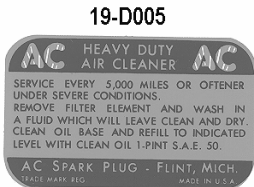

- 19-D005 1955-7 V8 4 brl. air cleaner decal
- 19-D075 Air cleaner decal or all passenger car "dual four-barrels" 1956 and later Requires 2. 1 for each air cleaner

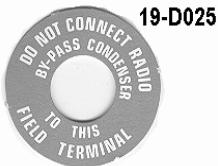

- 19-D025 Generator warning tag used on all models equipped with generators, 6 cyl. or V8 **\$3.00**

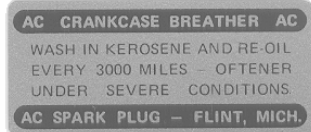

- 19-D026 Oil filter breather cap decal, used on all models, V8 & 6 cyl. Self adhesive
- 19-D027 Oil filter decal for 1955 V8's and all 6 cyl. cars
- 19-D028 1956 and 1957 oil filter decal for all V8's
- 19-D029 Oil filter decal for 1955 Chevy V8 cars with air conditioners only

- 19-D031 Chevy tire inflation decal for glove box door
- 19-D032 Air Conditioner window decal, 55-60
- 19-D033 Under dash air and heater instructions for dealer installed air conditioning
- 19-D034 Air condition Compressor decal
- 19-D035 2 Color aluminum tag for evaporator box on air-conditioned models, 1955-60 **\$5.00**
- 19-D036 "Blue flame 123" valve cover decal, 1955 6 -cyl. stick shift
- 19-D037 "Blue flame 136" valve cover decal 1955 6-cyl. with power glide
- 19-D038 "Blue flame 140" valve cover decal, all 1956-60

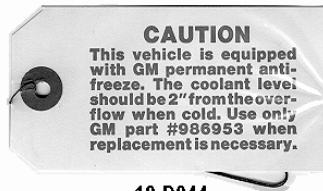

- 19-D044 "Radiator coolant tag", wire on for cars equipment with GM coolant
- 19-D045 1955 suggested delivered prices for cars and trucks including options
- 19-D046 1957 suggested delivered prices for cars and trucks including options
- 19-D048 Owners service policy, every new car owner was issued one of these
- 19-D049 Factory window sticker, fill in to match your model or options
- 19-D050 "Dealer window sticker" for dealer installed options
- 19-D051 Lacquer paint care instructions
- 19-D053 Battery guarantee 12 volt, issued to every new owner of car
- 19-D054 Breaking in instruction, "caution to new owner" All models
- 19-D055 New car adjustment and inspection sheet issued to every new car buyer when new
- 19-D056 Permanent aluminum door jam service record tag, adhesive back, Chevy logo
- 19-D057 Antenna adjustment tag for bottom of radio
- 19-D059 1955-1956 Clock Regulating, Cleaning and Adjusting Folder
- 19-D060 1957 Clock Regulating, cleaning and Adjusting Folder
- 19-D065 1955 Chevy color combinations and price folder



- 19-D066 Windshield washer bottle decal for manual operated units
- 19-D067 Windshield washer bottle decal for vacuum operated units
- 19-D068 Seat belt instruction card for use with all genuine Chevy seat belts
- 19-D069 1955-56 heater instruction tag
- 19-D070 Fuel injection air cleaner decal for 1957-1961 passenger cars,
- 19-D071 Window warning decal, "Protected by Electronic Alarm"
- 19-D084 "New car warranty limitations" - card explains what is covered by the dealer or owner, 1954 & up
- 19-D140 1955 Suggested sticker prices of new cars and trucks

SELF ADHESIVE DECALS

\$4.00 each

- 19-10558 AIR FILTER DECAL, 6 CYL
- 19-10560 AIR FILTER DECAL, V8 2B
- 19-10561 AIR FILTER DECAL, V8 4B
- 19-10562 OIL FILTER DECAL, 6 CYL & 55 V8 (black letters)
- 19-10742 OIL FILTER DECAL, 56-7 V8
- 19-10564 OIL FILLER CAP DECAL, 55-60

19-12697



- 19-12697 Radiator Coolant DECAL
- 19-10571 TIRE INFLATION DECAL
- 19-10566 VALVE COVER DECAL, 6 CYL, 55 STICK SHIFT '123'
- 19-10567 VALVE COVER DECAL, 6 CYL, 55 AUTOMATIC '136'
- 19-10743 VALVE COVER DECAL, 6 CYL, 56-7 '140'

19-1073

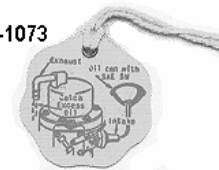

- 19-1073 Electro-Vac Tag & Decal, 57 FI w/Boost pump **35.00**

AUDIO SYSTEMS FOR YOUR CLASSIC FITS IN STOCK DASH OPENING

These radios are designed to fit right in your dash, in the original location with NO alteration at all, 100% bolt-in. All radios are guaranteed for 1 year, parts & labor, 2 years on parts only. Specific year instructions furnished. **All models come with original appearing knobs.** You may order these radios with a plain filler bezel on 55-6 models that do not have the original dash trim or if you are using custom dash trim. In addition Billet dash trim now available to fit these radios without using the filler bezel at all [See Group 12 Interior]. Plain Bezel applies to 55-6 only and means no dash trim pattern on filler bezel that surrounds radio face & mates it to the dash. All 57 radios all have a solid chrome filler bezel.

USA-230 AM/FM Radio

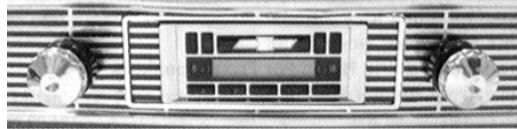

VECH-2-56



VECH-2-57

AM/FM Stereo.
\$220.

200 Watts. Digital Clock, Chrome face, NO CASSETTE PLAYER, Pre-sets (4 AM, 12 FM), 4-way fader, 4 channel RCA pre-outs. Power antenna lead. Auxiliary Input [RCA rear] RCA to 1/8 pin jack included for iPod, DVD, MP3, Satellite radio etc.

- VECH-2C-55 55 w/ 'Bel Air' Bezel VECH-2C-56 56 w/ 'Bel Air' Bezel
VECH-2C-55P 55 w/ Plain Bezel VECH-2C-56P 56 w/ Plain Bezel
VECH-2C-57 57 Chrome Face with Chrome Bezel

USA-SBR AM/FM Slide Bar Radio CD Controller, USB Interface



VECH-SBR57

Move the slide bar to the right & the analog AM radio display drops away to reveal a full featured digital display. With the large OEM pushbuttons you get a perfect look in a classic dash. **\$377.**

It has the latest features including an ipod dock. Navigation includes artist/song/album/playlist all from the buttons on the radio. You can keep your ipod hidden in your glovebox or console. USB input is in the back of the radio and allows you to plug in a flash drive for playback of MP3/WMA files. The LCD display shows the artist/song/album titles during playback of flashdrive, ipod or RDS radio station info. The LCD has 7 selectable color choices. Bluetooth is an option see #19-BLUKIT. 300 watts, auxiliary audio input in back for satellite radio etc., 25 presets, clock, power antenna lead, left/right balance front rear fader, subwoofer line out, etc. Direct CD1 control built in. .



VECH-SBR56



Digital Mode

- VECH-SBR-55 55 VECH-SBR-56 56 VECH-SBR-57 57

\$572. with single disc VECHCD-1 player

- VECH-SBR-55CD1 VECH-SBR-56CD1 VECH-SBR-57CD1
 All CD functions are controlled from the radio pushbuttons

CUSTOMAUTOSOUND CD Player



\$195.

VECHCD-1 Small Single CD Player: 7" wide, 1" high, 3-3/4" deep.

USA-630 AM/FM Radio CD Controller, USB Interface



USA-630 SHOWN IN 56 CHEVY DASH



USA-630 SHOWN IN 57 CHEVY DASH

AM/FM Stereo CD Controller
\$279.

USA-630 Radio AM/FM Flash Drive Player, Direct CD Controller 300 watt [4x60], USB input from back of radio 14" long extension; plays MP3/WMA files, Alpha numeric display for MP3/WMA files, 4 channel RCA pre-outs, Auxiliary input [RCA rear] RCA — 1/8" pin jack included, Separate bass & treble, Front/Rear Fader, Digital Clock, 12FM, 4AM presets, Power antenna lead, Electronic Volume/Tuning Controls. NO CASSETTE PLAYER. .

- VECH-630-55 55 w/ 'Bel Air' Bezel VECH-630-56 56 w/ 'Bel Air' Bezel
VECH-630-55P 55 w/ Plain Bezel VECH-630-56P 56 w/ Plain Bezel
VECH-2C-57 57 Chrome Face with Chrome Bezel

\$474. with single disc VECHCD-1 player

- VECH-630-55CD1 55 VECH-630-56CD1 56 VECH-630-57CD1 57
 All CD functions are controlled from the radio pushbuttons
VECH-630-55PCD1 55 Plain Bezel VECH-630-56PCD1 56 Plain Bezel

USA-740 AM/FM Radio CD Controller, USB, Bluetooth



AM FM CD Controller Radio
\$369.

VECH-740-55

AM/FM RDS Tuner 25 presets [15 fm 10 am]. RDS Tuner shoes, station/song/artist on display. 7 LCD color choices w/dimmer control. 300 watt peak, 2 ohm stable. Bluetooth & remote microphone included. Clock or function display switchable. Separate Bass / Mid / Treble Tone control w/DSP EQ. USB port for Flash Drive FLAC/WMA/MP3/WAV playback. Alpha numeric display for above. Electronic tuning & volume control w/last volume memory. 2 Aux inputs mini-jack Front & RCA Rear. Hi Volt 4 channel RCA preout. Subwoofer Pre-Out 3.3v w/electronic x-over for optional Subwoofer Amplifier. Direct CD control built in.

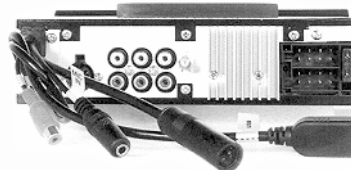

- VECH-740-55
 55 w/Bel Air Dash Trim
VECH-740-56
 56 w/Bel Air Dash Trim
VECH-740-57 57

- VECH-740-55P 55 w/ Plain Bezel VECH-740-56P 56 w/ Plain Bezel

\$564. with single disc VECHCD-1 player

- VECH-740-55CD1 VECH-740-56CD1 VECH-740-57CD1
VECH-740-55PCD1 55 Plain Bezel VECH-740-56PCD1 56 Plain Bezel

SST-V SECRET AUDIO

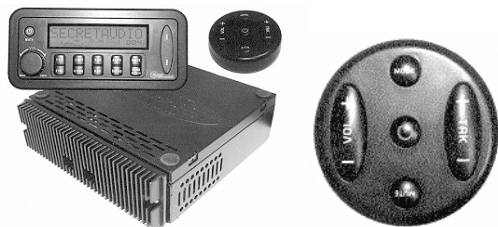

This is a 200 Watt hideaway audio system with exceptional quality that provides great flexibility for mounting. The main receiver/amplifier is usually hidden under the seat or behind the dash. Included is a flush mount bezel for LCD location to mount to console or dash. A swivel bracket is

supplied for installation in glove box or under dash or wherever you choose. LCD is 5" x 2" x 1" deep. iPod docking cable included. NO cassette. Electronically tuned AM/FM stereo, 200 watts 4x50. USB MP3/WMA Flash Drive Player. iPod Direct Control Interface built into tuner/amplifier. Alpha Numeric LCD Display shows artist/ song titles for USB, iPod & Satellite radio. Satellite radio Input for optional Sirius satellite radio tuner, CD Changer Controller for optional CD player [VECHCD-1]. Subwoofer Pre-Out. Electronic Volume, Base, Treble, Balance, Fader controls, 5 selectable iEQ Curves-pop/jazz/classic/beat/rock, Zero memory current draw [will not drain battery when unit not in use], 6 AM 18 FM Station Presets, Blue LED illumination on buttons & LCD display with contrast control You have a choice of Controllers, Instead of the flush mount bezel with the RF remote you can choose a wireless LCD controller [SRMS].

AM/FM CD Changer Controller
SST-V \$Call

USA-DIN AM FM CD Player

Not for Stock Dash Opening. Fits any vehicle with a 'DIN' opening 7.2" x 2.11". Folding & detachable face panel.



USA4-DIN Chrome

USB & Aux. IN on front panel. CD/MP3/ WMA / USB. 160watts [4 x 40]. RCA Preouts, separate bass & treble, front & rear Fader, ESP, Digital Clock. 18 FM, 12 AM presets. Seek, Scan, Auto Antenna Lead **\$Call**



USA4-DIN-BK Black

SPEAKERS & OTHER ACCESSORIES

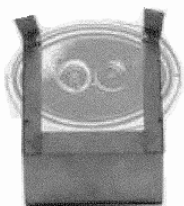

19-BRACE

19-BRACE 55-6 power pack & speaker replacement bracket, you will need if original is missing. Allows you to mount #19-1006 dual 4" speaker panel or a single 6"x 9" to it and to dash in original location. **\$31.**

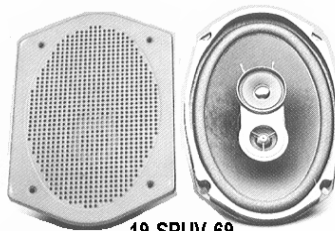

19-SPUV-69

19-SPUV-69 High Quality coaxial 6"x 9" speakers. Frequency ranges 55-20 kHz, 12 oz. magnet. Will handle up to 200 watts of power. Great for package tray and other applications. Bolts to stock rear speaker cutout in package shelf, also 57 dash. Will fit 55-6 dash if you modify stock speaker power pack bracket or use #19-BRACE
Pair **\$107.**

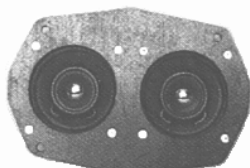

19-1006

Custom dual 4" panel bolts up to the 'power pack' speaker assembly bracket on 55-56 dash with no mods. On 57 it picks up original hole pattern in the dash. This speaker allows both 'sides' of stereo sound thru this single unit if no other speakers are to be installed

19-1006 30 watt **\$47.**

19-1006K 80 watt Kenwood **\$79.**

19-SPUV-69K 6" X 9" 400w dual cone w/grills Kenwood Pr **\$91.**
19-SPUV-69P 6" X 9" 400w 3 way w/grills Pioneer Pr **\$153.**

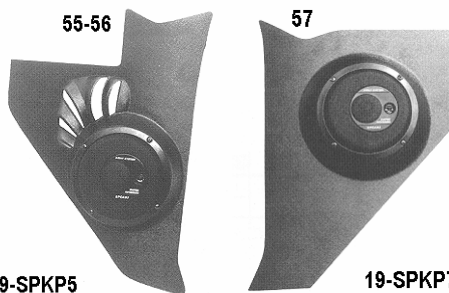

19-SPKP5

19-SPKP7

KICK PANEL SPEAKERS
Hard Plastic Textured Black



19-100DVC

Dash Dual Voice Speaker
Custom dual 4" panel bolts up to the 'power pack' speaker assembly bracket on 55-56 dash with no mods. On 57 it picks up original hole pattern in the dash. Prewired to plug into custom radios. This speaker allows both 'sides' of stereo sound thru this single unit if no other speakers are to be installed **19-100DVC \$59.**

Pairs (55-6 Louvered for full function of air vents.)
19-SPKP5 55-6 w/3 way 100-watt speakers **\$149.**
19-SPKP5A 55-6 w/Pioneer 200-watt coaxial speakers **213.**
19-SPKP7 57 w/3 way 100-watt speakers **\$149.**
19-SPKP7A 57 w/Pioneer 200-watt coaxial speakers **213.**



19-USS



19-USS2

19-USS This speaker system designed specifically for 'under seat' or horizontal 'wall' installations. The compact ABS housing contains 1 5 1/2" woofer and 2 Piezo tweeters in each enclosure and is only 2 7/8" high x 8" x 11". These sound very good and can handle up to 120 watts PAIR **\$141.**

19-USS2 UNDERCOVER ENCLOSED SPEAKERS this upgrade set has a 8" woofer & 2 Piezo tweeters in each box 200 watt capacity. Measure 11" W x 12.5" D x 3" H, PR **\$189.**



19-NONOISE

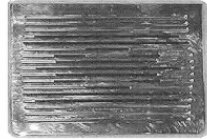

30-SG57P



30-SC556P

19-NONOISE Radio NOISE FILTER if after installation of a new stereo system you experience unwanted motor whine or engine noise check all grounds on radio am antenna etc. If you still have noise this filter may help **\$37.**

30-SG57P Billet Dash SPEAKER GRILL 57 ball milled **\$149.**

30-SG556P Billet Dash SPEAKER GRILL, 55-56 **\$108.**

30-SC556P Billet Dash SPEAKER GRILL COVER 55-6 **\$108.**

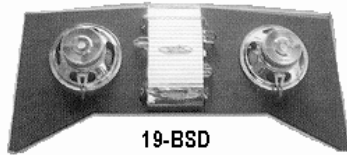

19-BSD

19-BSD BACKSEAT DRIVERS, Custom Bass Speaker Panel 2-8" subwoofers & BOSS 400 watt amp. Panel mounts to the back of the rear seat in the trunk. All cables & wires needed are included for quick & easy installation **\$257.**

CAS-SYSTEM-1 & 3

Allows you to keep the integrity of your vehicle intact. Satellite speakers look like AC vents and can be mounted under dash or on package shelf. The amplifier or the passive enclosure can mount under the seat.

CAS-SYSTEM-1 Flat active aluminum subwoofer enclosure w/3 channel amp. Two 3" mid-tweeter satellite speakers in die cast metal housings, 8" woofer. Wired remote for bass level. Installation Kit. 150watt sub woofer / 2 50 watt mid tweeter. Amp 2.8 x 13.50 x 9.80" Satellite 3.2 x 3.75" **\$ Call**

CAS-SYSTEM-3 Passive. Ported wood enclosure with w/ 5-1/4" dual voice coil woofer plus Two 3" mid-tweeter satellite speakers in die cast metal housings. Connects directly to your radio, no need for an amplifier. 300 watts max power. Enclosure 3 x8.25 x 11.25" Satellite 3.2 x 3.75" **\$ Call**



CAS-SYSTEM-1



19-ICAMKIT



19-USBFLASH



CAS-BLUKIT

19-USBFLASH USB MP3 Decoder, direct connection with cd quality sound, Power on automatic play function, Allows use of the radio CD controls to change songs/play list, 1/8" stereo jack for other auxiliary input **\$139.**

CAS-BLUKIT BLUETOOTH interface for USA-630 or Secretaudio Radios [made after 4/03] connects to 8 pin CD changer port of your radio and gives the ability to do hands free calling from your bluetooth capable phone & listen to music stored on your A2DP enabled bluetooth device. If you have a CD player attached to your radio it will still work with the adapter plugged in. **\$109.**

19-ICAMKIT IPOD Adapter; Direct connection [dock connector] with cd quality sound. Charges iPod & turns it off when radio is off. Power on automatic play function, Allows use of the radio CD controls to change songs/play list, 1/8" stereo jack for other auxiliary input **109.00**

ANTENNAS



ANT-1D



12-369A

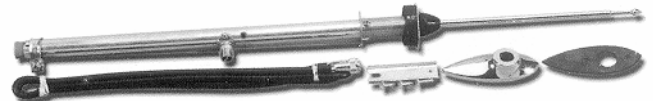

12-370A

ANT-1 Hidden ELECTRONIC ANTENNA, Designed to perform as well as a standard antenna without any external aerial showing. Mounts nicely inside on windshield under rear view mirror support, route wire under garnish trim. No external aerial. No drilling or grounding. Non-directional 3.5" long by 3/4" 12 volt power required **31.00**

ANT-1D Hidden ELECTRONIC ANTENNA, Dakota Digital premium quality **69.95**

Front Fender Antennas

Exact original comes w/ all hardware & instructions,

12-369F 55 Tear top mast (Fargo) **\$87. R**

12-369A 55 Tear top mast (Danchuk) **89. R**

12-370F 56-7 Ball top mast (Fargo) **\$87 R**

12-370A 56-7 Ball top mast (Danchuk) **89. R**



- 12-513** Antenna CABLE stock front fender antenna **14.00 R**
- 12-513** Antenna Base MOUNTING PLATE, screws to fender under base **3.90 R**
- 12-133D** Antenna BASE, chrome w/gasket, [Danchuk] **27.90 R**
- 12-133** Antenna BASE, chrome w/gasket, [Fargo] **21.90 RF**
- 12-137** Antenna Black PLASTIC NUT **4.50 R**
- 12-138** Antenna METAL NUT, goes under #12-137 **1.50 R**

Rear ANTENNAS



- 12-619F** 57 Rear LEFT assembly w/ lead complete **N/A**
- 12-620F** 57 Rear RIGHT assembly (Dummy as orig.) **N/A**
- 12-620A** 57 Rear RIGHT assembly Power Antenna (special order) **N/A**
- 12-528** NUT, 57 Rear Power Antenna, chrome **17.50 R**
- 12-529** NUT, 57 Rear Manual Antenna, chrome **N/A**
- 12-601** Antenna BASE, 57 Rear Right **29.50 R**

STOCK RADIO PARTS

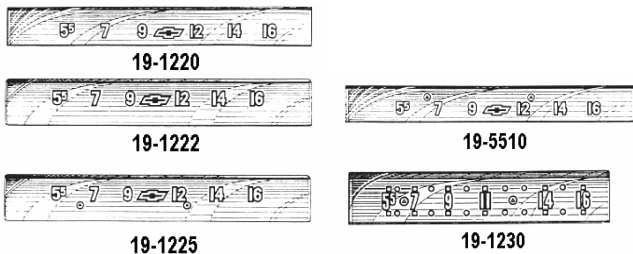

- Stock RADIO LENS**
- 19-1220** 55 'Wonderbar' **29.50 R**
 - 19-1222** 55 w/pushbutton radio **29.50 R**
 - 19-1225** 56 w/push-button radio **29.50 R**
 - 19-1230** 57 'Wonderbar' & push-button radio **29.50 R**
 - 19-5510** 56 'Wonderbar' **29.50 R**
 - 19-220A** CONTACT BAR Wonder Bar Radio 55-56 **N/A**

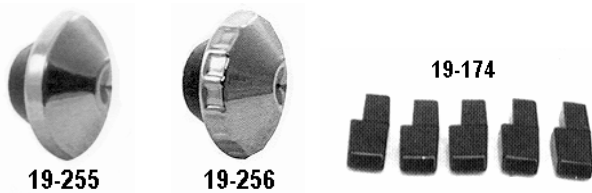

RADIO KNOBS

- 19-255** 55 original OUTER KNOB, fits either side, ea. **9.90 RF**
- 19-256** 56 original OUTER KNOB, fits either side, ea. **9.90 RF**
- 19-256A** 57 set/3 **39.00 R**
- 19-174** RADIO PUSHBUTTONS, 57, set of 5 **17.90 R**
- 30-RN57P** Billet RADIO KNOBS, 57 Pr [Back Roads Fabrication] **43.00 C**
- 19-152** Radio SUPPORT BRACKET, 55-6, underdash **15.95 R**
- 19-153** Radio SUPPORT BRACKET, 57, underdash **15.95 R**
- 21-241** Radio OZ-4 POWER TUBE Call Mike Hagan 215-547-7145
- 21-381** Radio VIBRATOR TUBE Call Mike Hagan 215-547-7145



- Radio Tone Control Knobs**
- 19-217** 57, Inner, ea. **4.95 R**
 - 19-183** 55-6, Pr. (foreign) **7.50 R**
 - 19-232** 55-6, Pr. USA, best quality **12.90 R**



- 21-263** RADIO GROUND STRAP, 8" **4.50 RP**
- 19-175** RADIO GROUND STRAPS, set of 3, w/instructions, all **24.00 R**

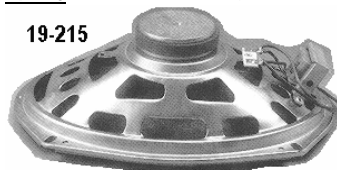

STOCK RADIO SPEAKERS

- 19-215** With transformer (rear speaker) **57.65 R**
- 19-216** Without transformer **50.45 R**
- 23-190** Radio SPEAKER BOOT, to Dash 55-6, rubber **29.00 R**



- 19-215A** CHROME repro will work with any 6 x9 speaker **35.00 R**
- 19-215B** BLACK repro will work with any 6 x9 speaker **25.00 R**
- 19-256B** 57 Speaker GRILL STUDS for stock dash grill **9.00 RP**
- 19-221** 57 Speaker GRILL for stock dash **125.00 R**

Group 19C

PAINTS

ENGINE ENAMELS

<u>10-149</u>	ORANGE	55, 57-80 V8	11.00 R
<u>10-149A</u>	Orange-Red Spray, darker than Orange		11.00 RP
<u>10-150</u>	Blue 6 cyl		13.99 R
<u>10-290RP</u>	RED 56 V8		11.00 R
<u>10-150A</u>	DULL ALUMINUM, Silver		11.00
<u>10-150B</u>	BLACK		11.00
<u>10-290</u>	RED		11.00
<u>10-298D</u>	CLEAR		11.00

DETAILING Colors

<u>10-293</u>	CAST BLAST, Cast Iron Look enamel perfect for parts you would normally clear or leave natural, allows you to prime & paint for lasting finish with original appearance	<i>Discontinued</i>
<u>10-293A</u>	Paint Cast Iron Gray 500° Spray Can replaces 10-293	16.00
<u>10-292</u>	ALUMI-BLAST, satin silver, fast dry looks like cad	11.00
<u>14-155B</u>	HAMMERTONE GRAY Heater Box Paint	<i>Discontinued</i>
<u>14-155B-1</u>	Heater Box GRAY PAINT Spray Can replacement	14.00
<u>10-291</u>	SEMI-GLOSS BLACK Enamel fast dry,	10.75
<u>10-291-2</u>	CHASSIS BLACK Enamel Spray Can	13.00
<u>10-291A</u>	SEMI-GLOSS BLACK Lacquer	12.00
<u>10-291B</u>	DULL BLACK Lacquer	12.00
<u>19-219A</u>	STAINLESS STEEL	12.00
<u>10-298A</u>	CLEAR Lacquer, UV resistant	11.00

HIGH TEMPERATURE Paints

<u>10-293C</u>	Header Paint BLACK	12.00
<u>10-293D</u>	Header Paint ALUMINUM	12.00
<u>10-293E</u>	Header Paint WHITE	12.00
<u>10-293B</u>	CAST BLAST 1200°, cast iron look	<i>Discontinued</i>
<u>10-293B1</u>	Header Paint Gray replaces 10-293B	16.00

PRIMERS

<u>10-298C1</u>	GREEN Self etching Primer, high quality metal protection	13.00
<u>10-298B</u>	RED OXIDE Primer, sandable	11.00
<u>10-298B1</u>	GRAY HOT ROD Primer, sandable	11.00
<u>10-298B2</u>	BLACK HOT ROD Primer, sandable	11.00
<u>10-298B2</u>	WHITE Primer, sandable	11.00



PAINT CHIP CHARTS \$12.95 Each	
Original Colors	
<u>19-157</u>	55
<u>19-158</u>	56
<u>19-159</u>	57

ORIGINAL COLORS IN SPRAY CAN Each \$18.95 Lacquer compatible 'A' part numbers replaced when sold out by the acrylic 'B' numbers
 N/A means no longer available remaining stock will be sold out and discontinued in both A & B numbers

<u>19-A1</u> Sea Mist Green 55	<u>19-A12</u> Harvest Gold 55	<u>19-B24</u> Matador Red N/A
<u>19-A2</u> Neptune Green N/A	<u>19-A13</u> Cashmere Blue N/A	<u>19-B25</u> Tropical Turq. N/A
<u>19-A3</u> Skyline Blue N/A	<u>19-B14</u> India Ivory N/A	<u>19-B26</u> Inca Silver N/A
<u>19-A6</u> Shoreline Beige N/A	<u>19-A15</u> Black Lacquer \$9.90	<u>19-A22</u> Calypso Cream 56
<u>19-A7</u> Autumn Bronze 55	<u>19-A16</u> Pinecrest Green 56	<u>19-A23</u> Harbor Blue N/A
<u>19-B8</u> Shadow Gray 55	<u>19-A17</u> Sherwood Green N/A	<u>19-B27</u> Imperial Ivory 57
<u>19-B9</u> Gypsy Red N/A	<u>19-B18</u> Nassau Blue 56	<u>19-B29</u> Surf Green 57
<u>19-B10</u> Regal Turquoise N/A	<u>19-A20</u> Crocus Yellow 56	<u>19-B30</u> Highland Green 57
<u>19-A11</u> Coral N/A	<u>19-B21</u> Twilight Turq 56	<u>19-B31</u> Colonial Cream 57
		<u>19-A32</u> Coronado Yellow N/A
		<u>19-B33</u> Sierra Gold N/A
		<u>19-A35</u> Canyon Coral 57
		<u>19-A36</u> Dusk Pearl N/A
		<u>19-A37</u> Laurel Green N/A
		<u>19-A40</u> Dune Beige N/A
		<u>19-A41</u> Dawn Gray 56
		<u>19-A43</u> Copper Maroon 55

